

DECISION OF THE BOARD OF APPEAL OF THE EUROPEAN UNION AGENCY FOR THE COOPERATION OF ENERGY REGULATORS

28 May 2021

(Application for annulment – ACER Decision No. 33/2020 – operational security coordination in Core CCR – ACER’s competence - principle of proportionality – principle of non-discrimination – duty to reason)

Case number	A-007-2021 (consolidated)
Language of the case	English
Appellants	TransnetBW GmbH (“ TransnetBW ” or “ Appellant I ”) Represented by: Thomas Burmeister and Petra Kistner, of White & Case LLP Polskie Sieci Elektroenergetyczne S.A.(“ PSE ” or “ Appellant II ”) Represented by: Leszek Jesień
Defendant	European Union Agency for the Cooperation of Energy Regulators (“ ACER ” or “ the Agency ”) Represented by: Christian Zinglensen
Intervener	Energy Regulatory Office (“ERO or “ the Intervener ”) Represented by : Jana Haasová On behalf of the Defendant.
Application for	Annulment and remittal of Decision No. 33/2020 of 4 December 2020 on the Methodology for Regional Operational Security Coordination for the Core Capacity Calculation Region adopted by the European Union Agency for the Cooperation of Energy Regulators (“ the Contested Decision ”).

THE BOARD OF APPEAL

composed of Andris Piebalgs (Chairman), Mariano Bacigalupo Saggese (Rapporteur), Yvonne Fredriksson, Walter Boltz, Michael Thomadakis and Marius Swora (Members).

Acting Registrar: Ronja Linßen

gives the following

DECISION

I. Legal background

1. Article 76 of Commission Regulation (EU) 2017/1485 of 2 August 2017 establishing a guideline on electricity transmission system operation (“SO”) entitled “*Proposal for regional operational security coordination*”, requires Transmission Systems Operators (“TSOs”) of each Capacity Calculation Region (“CCR”) to submit a proposal for a common methodology for regional operational security coordination (“ROSC”) for their region, no later than 3 months after the approval of the methodology for coordinating operational security analysis in Article 75(1) SO (“CSAM”) and lays down the regulatory requirements in relation to the adoption of the ROSC.
2. The bottom-up decision-making procedure for the adoption of the ROSC is set out in Article 6 SO entitled “*Approval of terms and conditions or methodologies of TSOs*”.
3. The Contested Decision - addressed to 16 TSOs of the Core CCR - adopts the ROSC for the Core CCR and joins it as Annex I to the Contested Decision.

II. Facts giving rise to the dispute

4. Pursuant to Article 5(1) and 6(3)(b) SO, TSOs of each CCR are required to develop a common proposal for ROSC in accordance with Article 76 SO and submit it to the competent NRAs.
5. All Core TSOs did not submit their ROSC proposal for the Core CCR by 19 September 2019.
6. In accordance with Article 5(9) SO, All Core TSOs informed Core NRAs and ACER about the failure to submit such a proposal. In accordance with 5(9) SO, ACER, in turn, informed the European Commission about All Core TSOs’ failure to submit their ROSC Proposal.
7. The European Commission suggested extending the deadline by 3 months, i.e. until 21 December 2019 for Core TSOs to submit their ROSC Proposal for approval.
8. All Core TSOs developed the ROSC Proposal for Core CCR (“**All Core TSOs’ ROSC Proposal**”).
9. Core TSOs published their ROSC Proposal for public consultation prior to its submission, from 23 September 2019 until 24 October 2019.
10. All Core TSOs submitted All Core TSOs’ ROSC Proposal to All Core NRAs. The submission of All Core TSOs’ ROSC Proposal was received by the last Core NRA on 31 January 2020. All Core TSOs’ ROSC Proposal was accompanied with a supporting Explanatory Document (“**All Core TSOs’ ROSC Explanatory Document**”)¹.
11. On 5 June 2020, the Chair of the Core Energy Regulators’ Forum informed ACER per email on behalf of All Core NRAs that they jointly agreed to request ACER to adopt a decision on All Core TSOs’ Proposal in accordance with Article 6(8) SO. As per Article 6(8) SO and Article 5(3) of Regulation (EU) 2019/942 (“**ACER Regulation**”), All Core NRAs referred All Core TSOs’ ROSC Proposal to ACER for regulatory approval in accordance with Article 6(10) ACER Regulation. This email was accompanied by All Core NRAs’ ROSC Non-Paper².

¹ https://eepublicdownloads.entsoe.eu/clean-documents/nc-tasks/EBGL/SO_GL_A76_CORE_CCR_Explanatory%20Note%20of%20Core%20ROSC%20Methodology.pdf

² <https://www.acer.europa.eu/en/Electricity/OPERATION-CODES/SYSTEM-OPERATION/Documents/Core%20Non-Paper%20on%20ROSC.pdf>

12. ACER launched a public consultation on All Core TSOs' ROSC Proposal from 4 September 2020 until 21 September 2020. The responses to the public consultation are joined as Annex II to the Contested Decision³.
13. As of 8 July 2020, ACER closely cooperated with All Core NRAs and Core TSOs and further consulted on the amendments to All Core TSOs' ROSC Proposal during numerous teleconferences and meetings and through exchanges of amendments. In this period, discussions were held within ACER's Electricity Working Group ("AEWG") and ACER's System Operation and Grid Connection Task Force ("SOGC TF").
14. From 13 October 2020 until 27 October 2020, ACER held a hearing phase as described in ACER's Rules of Procedure with All Core NRAs and All Core TSOs.
15. On 4 December 2020, the Board of Regulators ("BoR") gave its favourable opinion to the Agency's draft Contested Decision.
16. ACER issued the Contested Decision on 4 December 2020. Annex I to the Contested Decision contains the ROSC.

III. Procedure.

17. On 29 January 2021, Appellant I submitted its appeal to the Registry of the Board of Appeal against the Contested Decision in case A-003-2021.
18. On 1 February 2021, Appellant I's Appeal was received by the Registry of the Board of Appeal. The Registry of the Board of Appeal acknowledged it by notice of receipt of appeal.
19. On 4 February 2021, Appellant II submitted an appeal to the Registry of the Board of Appeal against the Contested Decision in case A-007-2021.
20. On 5 February 2021, Appellant II's Appeal was received by the Registry of the Board of Appeal. The Registry of the Board of Appeal acknowledged it by notice of receipt of appeal.
21. On 16 February 2021, the announcements of the appeals were published on the website of the Agency.
22. On 18 February 2021, case A-003-2021, which relates to three different ACER Decisions, was divided into three cases for procedural reasons, namely (i) case A-009-2021 regarding the appeal against ACER Decision No 30/2020; (ii) case A-010-2021 regarding the appeal against the Contested Decision and (iii) case A-011-2021 regarding the appeal against ACER Decision 35/2020.
23. On 18 February 2021, in accordance with Article 20(3)(h) of the Rules of Procedure, the Chairperson of the Board of Appeal consolidated appeal cases A-010-2021 and A-007-2021, involving similar issues and being related to the same Contested Decision 33/2020, into A-007-2021 (consolidated).
24. On 19 February 2021, the Registrar communicated the composition of the Board of Appeal to the Parties.
25. On 2 March 2021, the Registry of the Board of Appeal received the Intervener's application for leave to intervene on behalf of the Defendant.
26. On 5 March 2021, the Board of Appeal invited the Appellants to update the confidentiality status of their Appeal by 10 March 2021 in the light of the consolidation of the cases and access of other Appellants to the documents.
27. On 12 March 2021, the Registry informed the Appellants and the Defendant about the received application for leave to intervene along with an invitation to lodge observations to

³

https://acer.europa.eu/Official_documents/Acts_of_the_Agency/Individual%20decisions%20Annexes/ACER%20Decision%20No%2033-2020_Annexes/ACER%20Decision%2033-2020%20on%20Core%20ROSC%20-%20Annex%20II.pdf

the application and the opportunity to update the confidentiality status of their Appeal documents in light of the applications for leave to intervene by 19 March 2021.

28. On 18 March 2021, ACER filed its Defence with the Registry requesting the BoA to dismiss all appeals.
29. On 19 March 2021, Appellant I lodged observations on the merits of the application to intervene submitted by the Intervener.
30. On 23 March 2021, the Board of Appeal granted the Intervener the right to intervene on behalf of the Defendant.
31. On 23 March 2021, the Board of Appeal invited the Appellants to submit their Replies to the Defence, including further observations on the merits of the intervention of the Intervener, with a maximum of 15 pages, within the extended period of time of 8 April 2021.
32. On 23 March 2021, the Board of Appeal granted the Intervener access to the case documents and invited the Intervener to submit a second submission according to Article 11(9) of the Rules of Procedure. No second submission was submitted by the Intervener.
33. On 24 March 2021, the Defendant submitted a regularised Defence within the set deadline upon request of the Registry.
34. On 25 March 2021, the Board of Appeal extended the deadline for the Replies until 13 April 2021.
35. On 29 March 2021, the Board of Appeal allowed the Defendant to regularise its Defence beyond the set deadline, having received no objections to do so by the Appellants.
36. On 1 April 2021 a further extension for the Replies was granted until 14 April 2021.
37. On 14 April 2021, the Appellants filed their Reply to the Defence with the Registry.
38. On 15 April 2021, the Board of Appeal invited the Defendant to submit its Rejoinder, with a maximum of 15 pages, within the extended period of time of 7 May 2021.
39. On 28 April 2021, the Board of Appeal sent a First Request for Information to all parties in accordance with Article 20 of its Rules of Procedure.
40. On 3 May 2021, the Board of Appeal sent a Second Request for Information to the Defendant in accordance with Article 20 of its Rules of Procedure.
41. On 5 May 2021, all parties submitted their replies to the First Request for Information.
42. On 7 May 2021 the Defendant submitted its Rejoinder to the Registry.
43. On 10 May 2021, the Defendant submitted its reply to the Second Request for Information.
44. The Board of Appeal held an oral hearing on 17 May 2021.
45. On 19 May 2021, the Board of Appeal sent a Third Request for Information to all parties in accordance with Article 20 of its Rules of Procedure.
46. On 21 May 2021, all parties submitted their replies to the Third Request for Information.

IV. Main arguments of the Parties

47. The claims of each of the Appellants are duly summarised in each of the Consolidated Pleas, listed below:
 - First Consolidated Plea – Unlawful linking of the scope of the ROSC to the scope of the RDCTCS.*
 - Second Consolidated Plea – Amplification of the unlawful ROSC/RDCTCS linking by the RDCTCS’ priority of loop flows above the threshold.*
 - Third Consolidated Plea – Amplification of the unlawful ROSC/RDCTCS linking by the RDCTCS’ threshold for acceptable loop flows.*
 - Fourth Consolidated Plea – Unlawful transfer of responsibilities from TSOs to RCCs.*
 - Fifth Consolidated Plea – Disruption of the Central Dispatching Model.*
 - Sixth Consolidated Plea – Misalignment between locally and regionally optimal RAs to solve congestions.*
 - Seventh Consolidated Plea – Violation of TSOs’ OS responsibilities.*

48. The Appellants request the Board to rule on the remedies sought in Section VI.I below, Remedies Sought.
49. The Defendant requests the Board of Appeal (i) to dismiss the appeal of Appellant II because it is inadmissible and (ii) to dismiss the appeals of Appellants I and II in their entirety because they are unfounded.

V. Admissibility

V.I Ratione temporis

50. Article 28(2) ACER Regulation reads as follows: “*The appeal shall include a statement of the grounds for appeal and shall be filed in writing at ACER within two months of the notification of the decision to the person concerned, or, in the absence thereof, within two months of the date on which ACER published its decision*”.
51. ACER adopted the Contested Decision on 4 December 2020 and published the Contested Decision on its website on 8 December 2020.
52. On 29 January 2021, Appellant I submitted its appeal to the Registry of the Board of Appeal against the Contested Decision in case A-003-2021.
53. On 4 February 2021, Appellant II submitted an appeal to the Registry of the Board of Appeal against the Contested Decision in case A-007-2021.
54. Therefore, the appeals of Appellant I and Appellant II are admissible *ratione temporis*.

V.II Ratione personae

55. Article 28(1) of Regulation (EU) 2019/942 provides that “[a]ny natural or legal person, including the regulatory authorities, may appeal against a decision referred to in point (d) of Article 2 which is addressed to that person, or against a decision which, although in the form of a decision addressed to another person, is of direct and individual concern to that person.”
56. Article 2 of the Contested Decision stipulates that it is addressed to:
 1. 50Hertz Transmission GmbH,
 2. Amprion GmbH,
 3. Austrian Power Grid AG,
 4. C.N.T.E.E. Transelectrica S.A.,
 5. ČEPS a.s.,
 6. Creos Luxembourg S.A.,
 7. ELES, d.o.o.,
 8. Elia System Operator NV/SA,
 9. HOPS d.o.o., Hrvatski operator prijenosnog sustava,
 10. MAVIR ZRt,
 11. Polskie Sieci Elektroenergetyczne,
 12. Réseau de Transport d'Electricité,
 13. Slovenská elektrizačná prenosová sústava, a.s.,
 14. TenneT TSO B.V.,
 15. TenneT TSO GmbH, and
 16. TransnetBW GmbH.
17. The addressees of the Contested Decision are TSOs of the Core CCR.
18. Appellant I and Appellant II are Core TSOs listed as addressees of the Contested Decision.
19. Therefore, the appeals of Appellant I and Appellant II are admissible *ratione personae*.

V.III Ratione materiae

20. Article 28(1) ACER Regulation reads as follows: “*Any natural or legal person, including the regulatory authorities, may appeal against a decision referred to in point (d) of Article 2 which is addressed to that person, or against a decision which, although in the form of a decision addressed to another person, is of direct and individual concern to that person.*”
21. The Contested Decision is an individual decision of ACER in accordance with Article 2(d) ACER Regulation, which was issued on the basis of Articles 5(3) and 6(10) ACER Regulation, following a consultation with Core NRAs and Core TSOs.
22. ACER alleges in its Defence⁴ that the appeal of Appellant II is inadmissible because the remedy sought by Appellant II is not in accordance with Article 28(5) ACER Regulation.
23. ACER claims that the remedy sought by Appellant II requests the Board of Appeal to issue directions to ACER whereas the Board of Appeal can only confirm the Contested Decision or remit the case to the competent body of ACER in accordance with Article 28(5) ACER Regulation.
24. The remedy sought by Appellant II is as follows⁵:

“*The Appellant respectfully requests the Board of Appeal to rule that the Appellant's appeal is well-founded, and to annul the Contested Decision in its entirety and to remit the case to the competent body of ACER to replace the Contested Decision with a new decision in accordance with Article 28(5) of Regulation 2019/942. The new ROSC Methodology shall be drafted:*

 - i. in such a way as to respect the rule that the means and duties of RCCs are only complementary to the basic responsibilities imposed on the TSOs as well as limited to actions of regional relevance, i.e. technically and economically justified, necessary for TSOs and feasible at the regional level;*
 - ii. in such a way as to respect the rule that TSOs' responsibility for secure system operation can be performed by two equivalent models: central dispatching model and self-dispatch model;*
 - iii. in such a way as to ensure technically and economically effective utilisation of remedial measures, both in the regional scope and from the perspective of individual TSOs;*
 - iv. in such a way as to ensure that TSOs' responsibility for secure system operation can be effectively fulfilled by individual TSOs by providing them with the needed support at the regional level as well as access to the required resources and measures.*

Due to the high convergence of content between ROSC Methodology and RDCT Methodology, changes in the first one will entail the need to change the latter as well, in order to maintain consistency. Therefore, the relevant arguments presented in this Notice of Appeal also apply to RDCT Methodology.”
25. In its Reply⁶, Appellant I states it “*had requested and still requests the Board of Appeal to remit the case to the competent body of ACER (..)*.” and that it “*did not and still does not request the Board of Appeal to replace the Contested Decision with a new one.*”
26. Appellant II reiterated at the Oral Hearing that it requests the Board of appeal to remit the case to the competent body of ACER to replace the Contested Decision with a new one in accordance with Article 28 ACER Regulation.
27. The Board of Appeal finds that, when stating “*The Appellant respectfully requests the Board of Appeal to rule that the Appellant's appeal is well-founded, and to annul the Contested Decision in its entirety and to remit the case to the competent body of ACER to replace the Contested Decision with a new decision in accordance with Article 28(5) of Regulation 2019/942. The new ROSC Methodology shall be drafted: (..)*”, the appeal of Appellant II requests the Board of Appeal to remit the case to the competent body of ACER in accordance with Article 28(5) ACER Regulation.
28. The Board of Appeal furthermore observes that Article 28(5) ACER Regulation stipulates that ACER “*shall be bound by the decision of the Board of Appeal*”.
29. In the light of the above, the Board of Appeal concludes that the appeal of Appellant II is admissible.

⁴ Defence, paras 160-165.

⁵ Appeal II, paras 10-11.

⁶ Appellant I's Reply, para 5.

30. Therefore, the appeals of Appellant I and Appellant II are admissible *ratione materiae*.

VI. Merits

VI.I Remedies sought by the Appellants

31. The remedy sought by Appellant I is as follows⁷:

“We therefore request on behalf of the Appellant the Board of Appeal in accordance with Art. 28 para. 4 ACER Regulation to annul the contested decisions⁸ and refer them back to the competent body of the Agency for new decisions in compliance with the legal opinion of the Board of Appeal.”

32. The remedy sought by Appellant II is as follows⁹:

“The Appellant respectfully requests the Board of Appeal to rule that the Appellant's appeal is well-founded, and to annul the Contested Decision in its entirety and to remit the case to the competent body of ACER to replace the Contested Decision with a new decision in accordance with Article 28(5) of Regulation 2019/942.

The new ROSC Methodology shall be drafted:

i. in such a way as to respect the rule that the means and duties of RCCs are only complementary to the basic responsibilities imposed on the TSOs as well as limited to actions of regional relevance, i.e. technically and economically justified, necessary for TSOs and feasible at the regional level;

ii. in such a way as to respect the rule that TSOs' responsibility for secure system operation can be performed by two equivalent models: central dispatching model and self-dispatch model;

iii. in such a way as to ensure technically and economically effective utilisation of remedial measures, both in the regional scope and from the perspective of individual TSOs;

iv. in such a way as to ensure that TSOs' responsibility for secure system operation can be effectively fulfilled by individual TSOs by providing them with the needed support at the regional level as well as access to the required resources and measures.

Due to the high convergence of content between ROSC Methodology and RDCT Methodology, changes in the first one will entail the need to change the latter as well, in order to maintain consistency. Therefore, the relevant arguments presented in this Notice of Appeal also apply to RDCT Methodology.”

VI.II Pleas and arguments of the Parties.

First Consolidated Plea – Unlawful linking of the scope of the ROSC to the scope of the RDCTCS.

1.1 The Board of Appeal's appraisal of the RDCTCS scope.

1.1.1 ACER's regulatory supervision when adopting ACER Decision 30/2020 (RDCTCS).

1.1.2 RAs in the zonal market model.

1.1.3 The need for coordination of RAs in Core CCR.

1.1.4 Operational security in EU electricity regulation.

1.1.5 EU electricity regulation links the RDCTCS, RDCT and ROSC methodologies.

1.1.6 All 3 methodologies have duly been linked.

1.1.7 The RDCTCS is in line with the CACM, the ER and the PPP.

1.1.8 The blending of the scope of RAs deriving from CROSA was decided upon by ACER Decision 07/2019 and not appealed.

1.1.9 The RDCTCS infringes the principle of proportionality.

1.1.10 The RDCTCS scope allows for exceptions upon common agreement by All Core TSOs.

1.2 The RDCTCS scope refers to other methodologies.

1.3 The RDCTCS scope should match a “significant impact”-test or the scope of DA and ID Core CCM.

1.4 The RDCTCS scope infringes Article 74(2) CACM and is inconsistent per se.

1.5 The RDCTCS scope wrongly includes internal NEs.

1.6 The RDCTCS scope infringes Article 16(8), 16(4) and 16(13) ER.

1.7 The RDCTCS scope infringes Article 74(6)(a) CACM.

1.8 The RDCTCS scope infringes Article 74(6)(b) CACM.

1.9 The RDCTCS scope infringes Recital (12) CACM and 16(4) ER.

1.10 The RDCTCS scope infringes Article 35 CACM and 2(4) ER.

⁷ Appeal I, para 4.

⁸ As set out above in Section III, “Procedure”, the appeal of Appellant I relates to 3 different ACER Decisions, including the Contested Decision.

⁹ Appeal II, paras 10-11.

1.11 The RDCTCS contradicts the creation of the internal energy market.

1.12 The RDCTCS infringes the principle of non-discrimination.

1.13 Due reasoning of the RDCTCS scope.

Second Consolidated Plea – Amplification of the unlawful ROSC/RDCTCS linking by the RDCTCS’ priority of loop flows above the threshold.

2.1 Characteristics of the priority stack.

2.2 The decision-making process leading-up to ACER Decision 30/2020.

2.3 The validity of prioritising LFs above the threshold in the priority stack.

2.4 Prioritisation of LFs above the threshold contradicts the EU internal market fostering renewable energies.

2.5 Prioritisation of LFs above the threshold infringes Article 16(13) ER and the PPP.

2.6 Prioritisation of LFs above the threshold infringes Article 74(6)(a) CACM.

2.7 Prioritisation of LFs above the threshold infringes Article 74(6)(b) CACM.

2.8 Prioritisation of LFs above the threshold infringes the principle of non-discrimination.

Third Consolidated Plea – Amplification of the unlawful ROSC/RDCTCS linking by the RDCTCS’ threshold for acceptable loop flows.

3.1 Characteristics of the legitimate LF threshold.

3.2 The decision-making process leading-up to ACER Decision 30/2020.

3.3 The LF threshold requires a prior study and cannot be temporary.

3.4 The LF threshold is set at an incorrect value.

3.5 The LF threshold should not be fixed but floating and infringes Article 16(8) ER.

3.6 The LF threshold infringes Article 74(6)(e) CACM.

3.7 The LF threshold infringes the principle of proportionality.

3.8 The LF threshold infringes the principle of non-discrimination.

3.9 ACER’s competences when determining the LF threshold.

3.10 The LF threshold infringes the duty to reason.

Fourth Consolidated Plea – Unlawful transfer of responsibilities from TSOs to RCCs.

4.1 The creation of RSCs and RCCs.

4.2 The ROSC applies to XRAs.

4.2.1 The test is set by Article 9(1) of the Contested Decision’s ROSC.

4.2.2 The test: XRAs on XNEs.

4.2.2.1 The concept of XNEs.

4.2.2.2 The concept of XRAs.

4.2.3 Coordination requires the involvement of RSCs/RCCs.

Fifth Consolidated Plea – Disruption of the Central Dispatching Model.

Sixth Consolidated Plea – Misalignment between locally and regionally optimal RAs to solve congestions.

6.1 Misalignment between locally and regional optimal RAs to solve congestions.

6.2 Inadequate cost sharing solution in ROSC and RDCTCS.

6.3 Infringement of the ER, SO and ACER Regulation.

Seventh Consolidated Plea – Violation of TSOs’ OS responsibilities.

7.1 The Contested Decision did not substantially modify All Core TSO’s ROSC Proposal on voltage limits.

7.2 Inadequate rules on voltage limits in the Contested Decision’s ROSC.

7.3 A need for local management of voltage limits.

First Consolidated Plea – Unlawful linking of the scope of the ROSC to the scope of the RDCTCS.

33. Paragraph 182 of Appellant I’s appeal, entitled “RDCT Methodology and ROSC Methodology” reads as follows:

“As outlined above, main subject to the appeal is the RDCT Cost Sharing Methodology. However, the core questions of this appeal are which costs for cross-border relevant remedial actions exercised on cross-border relevant network elements can be included into the cost sharing mechanism pursuant to Art. 74 CACM in

conjunction with Art.16 para 13 Electricity Regulation and how those costs need to be shared between the transmission system operators of the Capacity Calculation Region Core. Nevertheless, the RDCT Cost Sharing Methodology does not include a definition for cross-border relevant network elements. As the respective definition for cross-border relevant network elements is included in Art. 5 RDCT Methodology, which is identical with Art. 5 ROSC Methodology, subject to this appeal are also the RDCT Methodology as well as the ROSC Methodology in order to avoid inconsistencies. Also, this aims at enabling the Board of Appeal to conduct a full review of the requests and pleas in law as described above in particular in the light of the Decision of the European Court of 18 November 2020 (Case T- 735/18 -Aquind Ltd., recital 80, 81) pursuant to which the Board of Appeal is bound to the Appellants requests and pleas in law, when deciding upon the appeal.”

57. Appellant I¹⁰ claims that ACER Decision 30/2020’s RDCTCS adopted an excessive definition XNEs included into the CA process after mapping, contrary to Article 74(2) CACM and 16(13) ER. Appellant I claims that after mapping, the RDCTCS should not have included all other internal NEs than the costs for RAs exercised on CB elements (interconnectors) as this infringes Article 74(2) CACM and 16(13) ER (read in conjunction with Recital (12) and Articles 35(2), 74(6) CACM, with Recitals (20) and (21) and Articles 1, 2(4), 16(4) ER and with the scope of the RDCTCS, RDCT and ROSC). It furthermore argues that, even if the RDCTCS were to exclude all other internal NEs after mapping as requested by Appellant I, ACER Decision 30/2020’s RDCTCS would still be unlawful because it should not have included internal CNEs, as this infringes Article 74(2) CACM and 16(13)ER. Appellant I adds that ACER did not take account of the possible impact on ACER Decision 30/2020 of pending procedures T-283/19 and T-631/19 before the GCEU on the legal validity of the definition of internal CNEs in ACER’s Decision 02/2019 on Core CCM.
58. In its Reply¹¹, Appellant I highlights that its appeal essentially relates to the interaction of ACER Decision 30/2020 (RDCTCS) with the Contested Decision. It underlines the procedural nature of the appeal following the division of its initial appeal case A-003-2020, which relates to three different ACER Decisions, into three cases for procedural reasons, namely (i) case A-009-2021 regarding the appeal against ACER Decision 30/2020 (RDCTCS); (ii) case A-010-2021 regarding the appeal against the Contested Decision (ROSC) and (iii) case A-011-2021 regarding the appeal against ACER Decision 35/2020 (RDCT).
59. ACER’s Defence¹² rejects the appeal and explains the determination of XNEs under Article 35 CACM, Article 74 CACM and Article 16 ER: (a) coordinated RDCT pursuant to Article 35 CACM constitutes a CROSA process; (b) XRAs under Article 35 CACM are XRAs under the CROSA process; (c) all coordinated RDCT actions determined by the CROSA to relieve physical congestion on XNEs are eligible for cost-sharing under Article 74 CACM; (d) Article 16(13) ER does not limit the scope of the RDCTCS under Article 74 CACM to RAs relieving physical congestion on interconnectors or CNEs.
60. The Intervener intervenes in the First Consolidated Plea on behalf of the Defendant.
61. At the Oral Hearing, Appellant I confirmed that, in its opinion, ACER Decision 30/2020 (RDCTCS) should not make any reference, as regards its scope, to the scope of the Contested Decision. Appellant I confirmed that, in the absence of such reference, it does not challenge the Contested Decision *per se*. In other terms, if the scope of ACER Decision 30/2020 (RDCTCS) were to be modified in order not to reflect the scope of the Contested Decision, it would have no objection against the Contested Decision.
62. Article 74 CACM, entitled “Redispatching and countertrading cost sharing methodology”, reads as follows:

¹⁰ Appeal I, Plea 1, paras 26-125.

¹¹ Reply of Appellant I, paras 1-3.

¹² Defence, paras 183-215.

1. No later than 16 months after the decision on the capacity calculation regions is taken, all TSOs in each capacity calculation region shall develop a proposal for a common methodology for redispatching and countertrading cost sharing.
 2. The redispatching and countertrading cost sharing methodology shall include cost-sharing solutions for actions of cross-border relevance.
 3. Redispatching and countertrading costs eligible for cost sharing between relevant TSOs shall be determined in a transparent and auditable manner.
 4. The redispatching and countertrading cost sharing methodology shall at least:
 - (a) determine which costs incurred from using remedial actions, for which costs have been considered in the capacity calculation and where a common framework on the use of such actions has been established, are eligible for sharing between all the TSOs of a capacity calculation region in accordance with the capacity calculation methodology set out in Articles 20 and 21;
 - (b) define which costs incurred from using redispatching or countertrading to guarantee the firmness of cross-zonal capacity are eligible for sharing between all the TSOs of a capacity calculation region in accordance with the capacity calculation methodology set out in Articles 20 and 21;
 - (c) set rules for region-wide cost sharing as determined in accordance with points (a) and (b).
 5. The methodology developed in accordance with paragraph 1 shall include:
 - (a) a mechanism to verify the actual need for redispatching or countertrading between the TSOs involved;
 - (b) an ex post mechanism to monitor the use of remedial actions with costs;
 - (c) a mechanism to assess the impact of the remedial actions, based on operational security and economic criteria;
 - (d) a process allowing improvement of the remedial actions;
 - (e) a process allowing monitoring of each capacity calculation region by the competent regulatory authorities.
 6. The methodology developed in accordance with paragraph 1 shall also:
 - (a) provide incentives to manage congestion, including remedial actions and incentives to invest effectively;
 - (b) be consistent with the responsibilities and liabilities of the TSOs involved;
 - (c) ensure a fair distribution of costs and benefits between the TSOs involved;
 - (d) be consistent with other related mechanisms, including at least: (i) the methodology for sharing congestion income set out in Article 73; (ii) the inter-TSO compensation mechanism, as set out in Article 13 of Regulation (EC) No 714/2009 and Commission Regulation (EU) No 838/2010 (1);
 - (e) facilitate the efficient long-term development and operation of the pan-European interconnected system and the efficient operation of the pan-European electricity market;
 - (f) facilitate adherence to the general principles of congestion management as set out in Article 16 of Regulation (EC) No 714/2009;
 - (g) allow reasonable financial planning;
 - (h) be compatible across the day-ahead and intraday market time-frames; and
 - (i) comply with the principles of transparency and non-discrimination.
 7. By 31 December 2018, all TSOs of each capacity calculation region shall further harmonise as far as possible between the regions the redispatching and countertrading cost sharing methodologies applied within their respective capacity calculation region.”
63. Article 16 Old ER has been replaced by Article 16 ER (“General principles of capacity allocation and congestion management”), which reads as follows:
- “1. Network congestion problems shall be addressed with non-discriminatory market-based solutions which give efficient economic signals to the market participants and transmission system operators involved. Network congestion problems shall be solved by means of non-transaction-based methods, namely methods that do not involve a selection between the contracts of individual market participants. When taking operational measures to ensure that its transmission system remains in the normal state, the transmission system operator shall take into account the effect of those measures on neighbouring control areas and coordinate such measures with other affected transmission system operators as provided for in Regulation (EU) 2015/1222.
 2. Transaction curtailment procedures shall be used only in emergency situations, namely where the transmission system operator must act in an expeditious manner and redispatching or countertrading is not possible. Any such procedure shall be applied in a non-discriminatory manner. Except in cases of force majeure, market participants that have been allocated capacity shall be compensated for any such curtailment.
 3. Regional coordination centres shall carry out coordinated capacity calculation in accordance with paragraphs 4 and 8 of this Article, as provided for in point (a) of Article 37(1) and in Article 42(1).

Regional coordination centres shall calculate cross-zonal capacities respecting operational security limits using data from transmission system operators including data on the technical availability of remedial actions, not including load shedding.

Where regional coordination centres conclude that those available remedial actions in the capacity calculation region or between capacity calculation regions are not sufficient to reach the linear trajectory pursuant to Article 15(2) or the minimum capacities provided for in paragraph 8 of this Article while respecting operational security limits, they may, as a measure of last resort, set out coordinated actions reducing the cross-zonal capacities accordingly. Transmission system operators may deviate from coordinated actions in respect of coordinated capacity calculation and coordinated security analysis only in accordance with Article 42(2). By 3 months after the entry into operation of the regional coordination centres pursuant to Article 35(2) of this Regulation and every three months thereafter, the regional coordination centres shall submit a report to the relevant regulatory authorities and to ACER on any reduction of capacity or deviation from coordinated actions pursuant to the second subparagraph and shall assess the incidences and make recommendations, if necessary, on how to avoid such deviations in the future. If ACER concludes that the prerequisites for a deviation pursuant to this paragraph are not fulfilled or are of a structural nature, ACER shall submit an opinion to the relevant regulatory authorities and to the Commission. The competent regulatory authorities shall take appropriate action against transmission system operators or regional coordination centres pursuant to Article 59 or 62 of Directive (EU) 2019/944 if the prerequisites for a deviation pursuant to this paragraph were not fulfilled.

Deviations of a structural nature shall be addressed in an action plan referred to in Article 14(7) or in an update of an existing action plan.

- 4. The maximum level of capacity of the interconnections and the transmission networks affected by cross-border capacity shall be made available to market participants complying with the safety standards of secure network operation. Counter-trading and redispatch, including cross-border redispatch, shall be used to maximise available capacities to reach the minimum capacity provided for in paragraph 8. A coordinated and non-discriminatory process for cross-border remedial actions shall be applied to enable such maximisation, following the implementation of a redispatching and counter-trading cost-sharing methodology.*
- 5. Capacity shall be allocated by means of explicit capacity auctions or implicit auctions including both capacity and energy. Both methods may coexist on the same interconnection. For intraday trade, continuous trading, which may be complemented by auctions, shall be used.*
- 6. In the case of congestion, the valid highest value bids for network capacity, whether implicit or explicit, offering the highest value for the scarce transmission capacity in a given timeframe, shall be successful. Other than in the case of new interconnectors which benefit from an exemption under Article 7 of Regulation (EC) No 1228/2003, Article 17 of Regulation (EC) No 714/2009 or Article 63 of this Regulation, establishing reserve prices in capacity-allocation methods shall be prohibited.*
- 7. Capacity shall be freely tradable on a secondary basis, provided that the transmission system operator is informed sufficiently in advance. Where a transmission system operator refuses any secondary trade (transaction), this shall be clearly and transparently communicated and explained to all the market participants by that transmission system operator and notified to the regulatory authority.*
- 8. Transmission system operators shall not limit the volume of interconnection capacity to be made available to market participants as a means of solving congestion inside their own bidding zone or as a means of managing flows resulting from transactions internal to bidding zones. Without prejudice to the application of the derogations under paragraphs 3 and 9 of this Article and to the application of Article 15(2), this paragraph shall be considered to be complied with where the following minimum levels of available capacity for cross-zonal trade are reached:
 - (a) for borders using a coordinated net transmission capacity approach, the minimum capacity shall be 70 % of the transmission capacity respecting operational security limits after deduction of contingencies, as determined in accordance with the capacity allocation and congestion management guideline adopted on the basis of Article 18(5) of Regulation (EC) No 714/2009;*
 - (b) for borders using a flow-based approach, the minimum capacity shall be a margin set in the capacity calculation process as available for flows induced by cross-zonal exchange. The margin shall be 70 % of the capacity respecting operational security limits of internal and cross-zonal critical network elements, taking into account contingencies, as determined in accordance with the capacity allocation and congestion management guideline adopted on the basis of Article 18(5) of Regulation (EC) No 714/2009. The total amount of 30 % can be used for the reliability margins, loop flows and internal flows on each critical network element.**

9. *At the request of the transmission system operators in a capacity calculation region, the relevant regulatory authorities may grant a derogation from paragraph 8 on foreseeable grounds where necessary for maintaining operational security. Such derogations, which shall not relate to the curtailment of capacities already allocated pursuant to paragraph 2, shall be granted for no more than one-year at a time, or, provided that the extent of the derogation decreases significantly after the first year, up to a maximum of two years. The extent of such derogations shall be strictly limited to what is necessary to maintain operational security and they shall avoid discrimination between internal and cross-zonal exchanges. Before granting a derogation, the relevant regulatory authority shall consult the regulatory authorities of other Member States forming part of the affected capacity calculation regions. Where a regulatory authority disagrees with the proposed derogation, ACER shall decide whether it should be granted pursuant to point (a) of Article 6(10) of Regulation (EU) 2019/942. The justification and reasons for the derogation shall be published. Where a derogation is granted, the relevant transmission system operators shall develop and publish a methodology and projects that shall provide a long-term solution to the issue that the derogation seeks to address. The derogation shall expire when the time limit for the derogation is reached or when the solution is applied, whichever is earlier.*
10. *Market participants shall inform the transmission system operators concerned within a reasonable period in advance of the relevant operational period whether they intend to use allocated capacity. Any allocated capacity that is not going to be used shall be made available again to the market, in an open, transparent and non-discriminatory manner.*
11. *As far as technically possible, transmission system operators shall net the capacity requirements of any power flows in opposite directions over the congested interconnection line in order to use that line to its maximum capacity. Having full regard to network security, transactions that relieve the congestion shall not be refused.*
12. *The financial consequences of a failure to honour obligations associated with the allocation of capacity shall be attributed to the transmission system operators or NEMOs who are responsible for such a failure. Where market participants fail to use the capacity that they have committed to use, or, in the case of explicitly auctioned capacity, fail to trade capacity on a secondary basis or give the capacity back in due time, those market participants shall lose the rights to such capacity and shall pay a cost-reflective charge. Any cost-reflective charges for the failure to use capacity shall be justified and proportionate. If a transmission system operator does not fulfil its obligation of providing firm transmission capacity, it shall be liable to compensate the market participant for the loss of capacity rights. Consequential losses shall not be taken into account for that purpose. The key concepts and methods for the determination of liabilities that accrue upon failure to honour obligations shall be set out in advance in respect of the financial consequences, and shall be subject to review by the relevant regulatory authority.*
13. *When allocating costs of remedial actions between transmission system operators, regulatory authorities shall analyse to what extent flows resulting from transactions internal to bidding zones contribute to the congestion between two bidding zones observed, and allocate the costs based on the contribution to the congestion to the transmission system operators of the bidding zones creating such flows except for costs induced by flows resulting from transactions internal to bidding zones that are below the level that could be expected without structural congestion in a bidding zone. That level shall be jointly analysed and defined by all transmission system operators in a capacity calculation region for each individual bidding zone border, and shall be subject to the approval of all regulatory authorities in the capacity calculation region.”*

64. Article 16(13) ER contains the Polluter Pays Principle (“PPP”) : it requires NRAs to allocate costs to the TSOs on the basis of whether they create flows from internal BZ transactions that contribute to the congestion between 2 BZs observed (above a threshold).

65. Article 1 of ACER Decision’s 30/2020 (RDCTCS)¹³ reads as follows:

“Article 1 - Subject matter and scope.

1. *This cost sharing methodology is the common methodology for redispatching and countertrading cost sharing in accordance with Article 74 of the CACM Regulation. It covers the sharing of costs of cross-border relevant redispatching and countertrading actions activated pursuant to the coordination process as*

13

https://acer.europa.eu/Official_documents/Acts_of_the_Agency/Individual%20decisions%20Annexes/ACER%20Decision%20No%2030-2020_Annexes/ACER%20Decision%2030-2020%20on%20Core%20RDCT%20Cost%20Sharing%20-%20Annex%20I.pdf

defined in the methodology pursuant to Article 35 of the CACM Regulation and the methodology pursuant to Article 76 of the SO Regulation. If this coordination process and its optimisation results in activation of other costly remedial actions, these costs shall also be included in the total costs to be shared in accordance with this methodology. This cost sharing methodology shall apply to all Core TSOs.

2. This cost sharing methodology shall also apply to third country TSO(s), if such TSO(s) have signed an agreement with all Core TSOs that they shall comply with this cost sharing methodology, as well as the methodology pursuant to Article 35 of the CACM Regulation and the methodology pursuant to Article 76 of the SO Regulation and accept all the rights and obligations stemming from them. In such case the reference to Core TSO(s) and Core CCR in this methodology shall also include such third country TSO(s)."

66. Articles 3 of ACER Decision's 30/2020 (RDCTCS) reads as follows:

"Article 3. XRAs and XNECs eligible for cost sharing.

1. This cost sharing methodology covers the sharing of costs and revenues of the cross-border relevant redispatching and countertrading actions that are determined as eligible for cost sharing in accordance with the methodology pursuant to Article 35 of the CACM Regulation and the methodology pursuant to Article 76 of the SO Regulation.
2. In accordance with Article 74(4)(b) of the CACM Regulation, all cross-border relevant redispatching and countertrading actions activated pursuant to the coordination process as defined in the methodology pursuant to Article 35 of the CACM Regulation and the methodology pursuant to Article 76 of the SO Regulation shall be considered as guaranteeing the firmness of cross-zonal capacities calculated in accordance with the capacity calculation methodology pursuant to Articles 20 and 21 of the CACM Regulation.
3. The costs and revenues of all cross-border relevant redispatching and countertrading actions activated pursuant to the common regional coordination and optimisation process as defined in the methodology pursuant to Article 35 of the CACM Regulation and the methodology pursuant to Article 76 of the SO Regulation shall be considered as eligible for cost sharing.
4. All cross-border relevant network elements shall be eligible for cost sharing in accordance with this cost sharing methodology.
5. In accordance with Article 74(4)(a) of the CACM Regulation, the costs of redispatching and countertrading actions, as well as other remedial actions considered in the capacity calculation, shall not be eligible for cost sharing, unless these actions have been confirmed to be activated within the common regional RAO process as defined in paragraph 3.
6. The eligible costs and revenues shall include only the costs and revenues of the cross-border relevant redispatching and countertrading actions that are determined as eligible for cost sharing in accordance with the methodology pursuant to Article 35 of the CACM Regulation and the methodology pursuant to Article 76 of the SO Regulation. In particular, any capacity and reservation costs shall not be eligible for cost sharing.
7. The eligible costs and revenues shall be auditable and transparent.
8. The total costs of cross-border relevant redispatching and countertrading actions eligible for cost sharing shall be determined as the netted sum of costs and revenues arising from the cross-border relevant redispatching and countertrading actions activated pursuant to the common regional RAO process as defined in the methodology pursuant to Article 35 of the CACM Regulation and the methodology pursuant to Article 76 of the SO Regulation."

67. Article 2(2)(j) of ACER Decision's 30/2020 RDCTCS defines CB relevant network element ("XNEs") as "a network element identified as cross-border relevant and on which operational security violations need to be managed in a coordinated way".

68. Article 2(2)(l) of ACER Decision's 30/2020 (RDCTCS) defines eligible XNE or eligible XNEC as "XNE or XNEC, which is eligible for cost sharing in accordance with this cost sharing methodology".

69. Article 7(1) of ACER Decision's 30/2020 (RDCTCS) states, with respect to the distribution of costs on XNECs to TSOs, that "All Core TSOs shall use the flow components on each eligible XNEC to calculate the share of the total costs attributed to eligible XNEC that shall be attributed to each TSO from the Core CCR. The calculations shall consist of the following steps:

- (i) Application of threshold(s) as described in paragraphs 2 to 5;
- (ii) Identification of contributions to congestion as described in paragraph 6; and
- (iii) Distribution of costs to bidding zones and TSOs as described in paragraphs 7 and 8."

70. It appears from the above that ACER Decision’s 30/2020 (RDCTCS) for Core CCR covers the sharing of costs of RDCT actions activated pursuant to the coordination and optimisation processes defined in Article 35 CACM and Article 76 SO.
71. The scope of ACER Decision’s 30/2020 (RDCTCS) refers to and matches the scope of (i) the common RDCT methodology (“RDCT”) that has been adopted in ACER Decision 35/2020 of 4 December 2020 (“ACER Decision 35/2020”¹⁴) in accordance with Article 35 CACM; and (ii) the common methodology for regional operational security coordination (“ROSC”) that has been adopted in the Contested Decision in accordance with Article 76 of Regulation (EU) 2017/1485 establishing a guideline on electricity transmission system operation (“SO”).
72. The scope of the RDCT is to be found in Article 5(1) of ACER Decision 35/2020’s RDCT, which states that XNEs are (i) all critical network elements (“CNEs”) included in the final list of CNEs in the Core day-ahead and intraday common capacity calculation methodologies (“DA Core CCM and ID Core CCM”) in accordance with CACM (Annexes I and II to ACER Decision 02/2019¹⁵) and (ii) all other NEs ≥ 220 kV within the control area of Core TSOs. Exceptions can be agreed upon by Core TSOs.
73. The scope of the ROSC is to be found in Article 5(1) of the Contested Decision’s ROSC, which similarly states that XNEs are (i) all CNEs included in the final list of CNEs in the DA Core CCM and ID Core CCM of Core in accordance with CACM (Annexes I and II to ACER Decision 02/2019) and (ii) all other NEs ≥ 220 kV within the control area of Core TSOs. Exceptions can be agreed upon by Core TSOs.
74. Graphically, the scope of the RDCTCS is as follows:

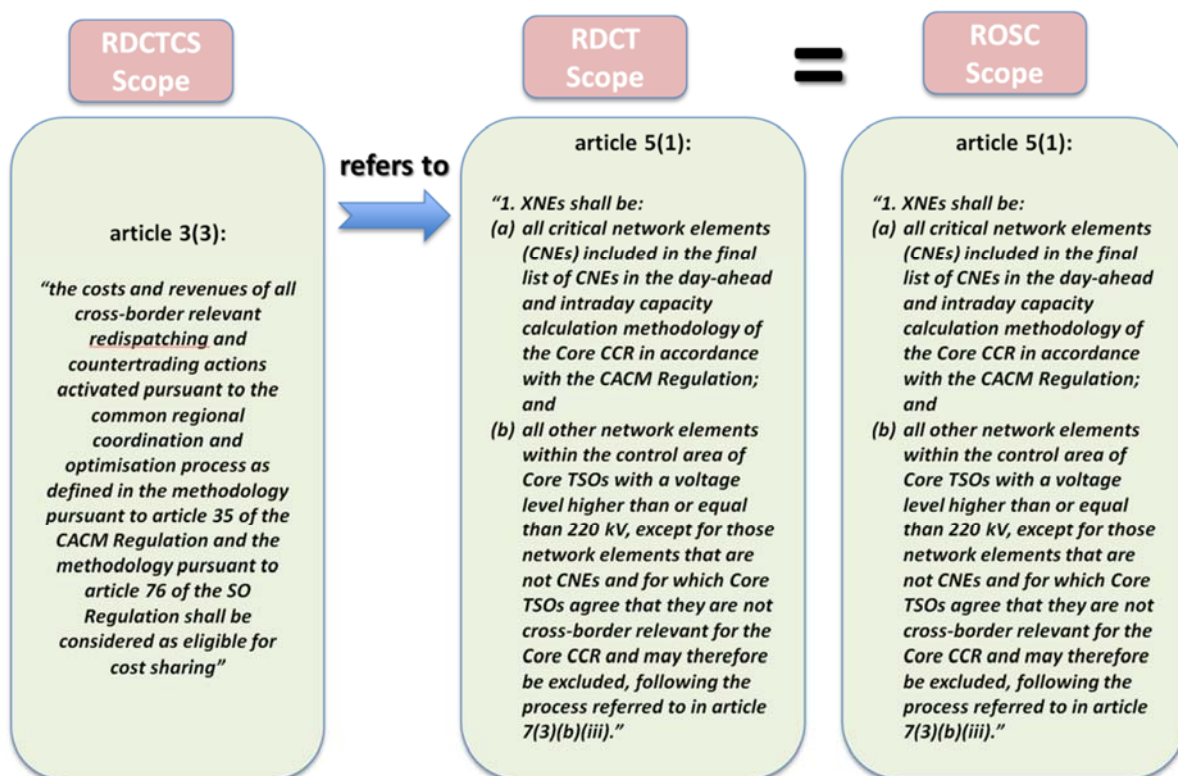

14

https://acer.europa.eu/Official_documents/Acts_of_the_Agency/Individual%20decisions/ACER%20Decision%2035-2020%20on%20Core%20RDCT%2035.pdf

15

https://www.acer.europa.eu/Official_documents/Acts_of_the_Agency/Individual%20decisions/ACER%20Decision%202019-2020on%20CORE%20CCM.pdf

Source: Board of Appeal.

75. The scope of the ROSC, RDCT and RDCTCS is therefore as follows:

XNEs =

Includes: • **all CNEs (CCM)** (according to a yearly list of CNEs):

- all CZ NEs
- all internal NEs, defined by All Core TSOs, with a BZ-to-BZ PTDF \geq 5%

• **other NEs \geq 220 kV**

Excludes: XNEs that are not CNEs, i.e.:

- radial lines, distribution NEs, transformers with secondary voltage <220 kV
- other NEs as commonly agreed upon by All Core TSOs
- XNEs that are part of another CCR CROSA (for TSOs belonging to more than one CCR)

Source: Board of Appeal.

1.1 The Board of Appeal's appraisal of the RDCTCS scope.

1.1.1 ACER's regulatory supervision when adopting ACER Decision 30/2020 (RDCTCS).

76. First, All Core TSO's RDCTCS Proposal provided in its Title II, "Eligible Costs for Cost Sharing", Article 4, the "Eligible Costs":

*"1. This Cost Sharing Methodology covers costs and revenues incurred by Core TSOs from using redispatching and countertrading, including measures identified as **actions of cross-border relevance as defined in the Core RD and CT Methodology**. These are used **to guarantee the firmness of crosszonal capacity in accordance with article 74(4)b of CACM guideline and to ensure security of supply**, taking into account the exceptions pursuant to paragraph 3 of Article 4 of this methodology. The eligible costs and revenues:*

- a. shall be auditable and transparent;*
 - b. shall occur from activations **as a result of the process in accordance with the methodology pursuant to article 76(1) of SO guideline**. These costs and revenues shall be: i. in case of countertrading, the incurred costs to solve congestions, consisting out of costs and revenues for activated countertrading resources as described in the article 6 of Core RD and CT Methodology; ii. in case of redispatching, the incurred costs to solve congestions, consisting of costs and revenues for upward and downward regulated energy, provided individually for each upward or downward activation as described in the article 11 of Core RD and CT Methodology.*
 - c. shall include only the costs and revenues realized by the activation of redispatching and countertrading measures as defined in the Core RD and CT Methodology. Capacity costs are not eligible for cost sharing in accordance with article 11(3) of the Core RD and CT Methodology.*
- 2. The total costs resulting from the eligible costs defined in paragraph 1 of this Article are determined as the netted sum of both, the countertrading costs defined in paragraph 1(b)(i) and the redispatching costs defined in paragraph 1(b)(ii).*
- 3. Some costs related to activation of CT and RD measures are not eligible for cost sharing. Costs noneligible for cost sharing are the costs incurred by the activation of remedial actions related to: a. uncoordinated LTA as not in line with the methodology pursuant article 10(1) FCA guideline (if applicable); b. emergency requests. In particular, but not limited to this situation, a TSO can face a critical situation, without being able to solve it by itself. This TSO can ask neighbouring Core TSOs for their support. Such request can lead to overloads on internal or external network elements, which need to be relieved via CT and RD measures. Costs related to implement the request are paid by the TSO that initiated the request; c. other reasons than violation of thermal limits following N or N-1 situations as defined in the methodology pursuant to article 75(1) SO guideline; d. Uncoordinated Remedial Actions by Core TSO that lead to overload on some network elements.*
- 4. Other costs related to activation of CT and RD measures not eligible for cost sharing are the costs incurred by: a. the activation of uncoordinated CT and RD measures; b. the activation of remedial actions decided during the capacity calculation process defined in the Core DA and ID CC Methodologies (if applicable). In particular, but not limited to this situation, during (day-ahead or intraday) capacity calculation, a TSO can decide to*

transparently include CT and RD measures that it has at its disposal (in its own grid or through an agreement with another TSO(s)) to enlarge the capacity domain.

5. Those costs not eligible for cost sharing shall be borne by: a. Core TSOs that have implemented these measures for those costs described in the paragraphs 3(c), 4(a) and 4(b) of this Article; b. Core TSOs that have requested the activation of emergency requests or uncoordinated LTA in the paragraphs 3(a) and 3(b) of this Article; c. Core TSOs that applied Uncoordinated Remedial Actions leading to the activation of countertrading and redispatching measures according to paragraph 3(d) of this Article.

6. The optimisation realised under the scope of the methodology pursuant to article 76(1) of the SO guideline solves congestions on network elements which can either be XBRNE or non-XBRNE. The costs eligible for cost sharing as considered in this methodology are defined as the costs mapped to the XBRNE pursuant to Article 9. The costs mapped to non-XBRNE shall be borne by Core TSOs in which control area the network element is located.

7. Total costs for cost sharing shall be determined on bidding zone level. These costs per bidding zone shall be allocated to the responsible Core TSOs, active in the respective bidding zone.” (emphasis added)

77. All Core TSO’s RDCTCS Proposal consequently referred to actions of CB relevance (“XRAs”) as defined in the RDCT, whilst also acknowledging the link between the RDCTCS, on the one hand, and security of supply and CROSA, on the other hand.

78. All Core TSOs’ RDCT Proposal¹⁶, in turn, stated in its Article 4 that XBRNEs were transmission systems of ≥ 220 kV “which were fully or partly located in their own control area” and added that all XBRNEs were “subject to RD and CT cost sharing.”

79. All Core TSOs’ RDCT Proposal, which All Core TSOs published on the same day as their RDCTCS Proposal (22 February 2019) defined XBRNEs as follows:

“1. All XBRNE selected according to Paragraphs 2 to 6 are subject to RD and CT cost sharing.

2. Each Core TSO shall define a list of initial XBRNE of transmission systems of 220 kV and higher voltages, which are fully or partly located in their own control area. Each Core TSO shall define this list based on operational experience. The lists of initial XBRNE shall include all cross-zonal network elements and may include also internal network elements, whereby these elements may be an overhead line, an underground cable, or a transformer. This list shall be updated at least on a yearly basis and shall be updated in case of significant network developments and related topology changes.

3. Each Core TSO shall define a list of proposed contingencies used in operational security analysis in accordance with Article 33 of the SO guideline. The contingencies of a Core TSO shall be located within the observability area of that Core TSO. This list shall be updated at least on a yearly basis and in case of network developments and related topology changes. A contingency can be an unplanned outage of a: a. (HVDC) line, cable, or transformer; b. busbar; c. generating unit; d. load; e. set of the aforementioned contingencies.

4. Each Core TSO shall associate the contingencies and the corresponding observability area established pursuant to Paragraph 3 with the XBRNE established pursuant to Paragraph 2 following the rules established in accordance with the methodology pursuant to Article 75(1) of SO guideline. Until such rules are established and enter into force, the association of contingencies to XBRNE shall be based on each Core TSO’s operational experience.

5. Each Core TSO shall define the list of XBRNE as follows: a. From the list of initial XBRNE, it shall remove those internal XBRNE, for which the maximum zone-to-zone power transmission distribution factor (hereafter referred to as “PTDF”) is not higher than five percent. The estimation of the zone-to-zone PTDF is described in Annex 1 of this methodology; b. From the remaining list of XBRNE, it shall remove those internal XBRNE which are not included in the list of internal XBRNE pursuant to Paragraph 6. This step shall not be performed until 30 days after the decision on the proposal for amendment of this methodology defining the list of internal XBRNE to be included in the list of XBRNE pursuant to Paragraph 6 becomes effective.

6. In the amended methodology in accordance with Article 19 Paragraph 4, Core TSOs shall jointly develop the criteria for the internal network elements to be excluded from the remaining XBRNE. In this development, Core TSOs will perform an impact assessment of increasing the threshold of maximum zone-to-zone PTDF for exclusion of internal XBRNE pursuant to Paragraph 5.a up to 10% at a later stage.” (emphasis added).

80. Said definition of XBRNEs clearly acknowledges a link between the RDCTCS and OS.

¹⁶<https://eepublicdownloads.entsoe.eu/clean-documents/Network%20codes%20documents/Implementation/ccr/methodologies/core/cacm-deliverables/coordinated-rd-and-ct-art-35/201902-core-cacm-35-methodology.pdf>.

81. However, All Core TSOs' RDCTCS Proposal made a distinction between XNEs as defined in the RDCT, called "XBRNE" in the Proposal, on the one hand, and non-XBRNE, on the other hand. Article 9 of All Core TSOs' RDCTCS Proposal stated:

"1. The remedial action optimisation realised under the scope of the methodology pursuant to article 76(1) SO guideline solves congestions on network elements which can be XBRNE or non-XBRNE.

2. The cost of applied remedial actions shall be mapped to the congested elements of the Core bidding zones relieved by the remedial action optimisation.

3. Mapping shall be performed on XBRNE and non-XBRNE in an hourly resolution.

4. Core TSOs shall take into account in the mapping process: a. the final costs resulting from remedial actions activated as an output of the remedial action optimization according to the methodology pursuant of article 76(1); b. the CGM used in the relevant CSA; c. the outputs of the relevant CSA regarding congested elements.

5. The results of the mapping shall be hourly costs allocated to XBRNEs and non-XBRNEs in [€]."

Article 10 of All Core TSOs' RDCTCS Proposal stated:

"1. Determine bidding zone costs per network element: a. To obtain the costs in [€] for each network element per bidding zone and hour, the costs mapped to each network element shall be multiplied with the respective BZ-shares per network element; b. For XBRNEs, the BZ-shares shall be the outcomes of transformation (as defined in Article 8); c. For non-XBRNEs, the bidding zone in which the non-XBRNE is located shall receive the full costs mapped to the element (100% of that bidding zone).

2. Aggregation of costs on bidding zone level: a. To obtain the final costs per bidding zone, the costs per bidding zone and hour are summed up for all hours and congested network elements, for which remedial actions have been activated. The result shall be one value per Core bidding zone in [€]"

82. All Core TSOs' RDCTCS Explanatory Document¹⁷ merely stressed that the input for the XBRNE was related to the methodology in accordance with Article 35(2) CACM. It furthermore referred to Article 14 of All Core TSO's RDCT Proposal¹⁸, which referred to the activation in DA and ID processes and considered the possibility for an additional request for coordination and reconsideration of ordered RDCT in the following cases "by the RA Connecting TSO(s), in case a provider of the RD or CT resource is not able to deliver the amount of Ordered Redispatching and/ or Ordered Countertrading or only parts of it on short notice; case an improved grid situation occurs. This may lead to cancellation or reduction of Ordered Redispatching and/ or Ordered Countertrading if it is technically and operationally feasible and when economically proven to be efficient".

83. All Core NRAs' RDCTCS Non-Paper evidenced divergent positions¹⁹ (XBRNEs being defined either as interconnectors or as CNEs as per CCM or as NEs ≥ 220 kV).

84. Subsequently, All Core TSOs' RDCTCS Non-Paper²⁰ evidenced divergent positions. Yet again, All Core TSOs acknowledged the link between the RDCTCS and OS, with an express referral to Article 15 of ACER Decision 07/2019 containing the EU-wide CROSA methodology, adopted under Article 75 SO ("CSAM"²¹) in its section "Elements relevant for cost-sharing (XBRNE)": "In accordance with article 15(2) of the methodology pursuant to article 75(1) SO Regulation, TSOs shall define the rules and/or criteria to establish the cross-border relevant network elements (XNEs) for which the costs attributed to them shall be shared among the involved TSOs. Core TSOs have referred to the methodology pursuant to article 35(1) CACM Regulation to define these principles. Core TSOs have named these XNEs relevant for cost-sharing in an earlier stage already XBRNEs (before the methodology in pursuance with article 75(1) went into force)". It listed the different positions of Core TSOs: 9 TSOs were of the opinion that only tie-lines had to be considered and 7 TSOs were of the opinion that tie-lines and internal NEs had to be considered, though with different nuances.

¹⁷ Annex 13 to the Defence, p. 4 and 5.

¹⁸ <https://eepublicdownloads.entsoe.eu/clean-documents/Network%20codes%20documents/Implementation/ccr/methodologies/core/cacm-deliverables/coordinated-rd-and-ct-art-35/201902-core-cacm-35-methodology.pdf>

¹⁹ Contested Decision, para 23.

²⁰ ACER Decision 30/2020, para 25.

²¹ <https://eepublicdownloads.entsoe.eu/clean-documents/Network%20codes%20documents/Implementation/ccr/methodologies/core/cacm-deliverables/coordinated-rd-and-ct-art-35/20190117-core-report-harmonization-cacm-353-nrasfinal.pdf>

Some considered XBRNEs to be CNECs considered in DA Core CCM. Others considered XBRNEs to be at least current CNECs, i.e. determined by zone-to zone PTDF $\geq 5\%$ and at most XNEs from ROSC, i.e. all overloaded elements ≥ 220 kV. Others considered XBRNEs to be internal NEs over which LFs and unscheduled PST flows exceed a LF threshold. Others considered XBRNEs to be tie-lines and internal NEs with PTDF $\geq 5\%$. Others considered XBRNEs to be XNEs defined in order to ensure consistency between the RDCTCS and the ROSC.

85. Article 15 of the CSAM, entitled “*Identification of cross-border relevant network elements and remedial actions*” states:
- “1. The cross-border relevant network elements (‘XNEs’) shall be all critical network elements (‘CNEs’) and other network elements above the voltage level defined by TSOs, except for those elements for which all TSOs in a CCR agree that they are not cross-border relevant for the concerned CCR and may therefore be excluded.
2. The common provisions for regional operational security coordination pursuant to Article 76(1) of the SO Regulation shall define the rules and/or criteria to establish the XNEs for which the costs attributed to them shall be shared among the involved TSOs and the XNEs for which the costs attributed to them shall be covered solely by the XNE connecting TSO(s), taking into account rules for cost sharing in accordance with Article 74 of the CACM Regulation.”
86. ACER carried out the regulatory supervision of All Core TSOs’ RDCTCS Proposal under the CACM which had been referred to it by All NRAs in accordance with the CACM’s referral procedure. In so doing, ACER found that the scope of the RDCTCS was not in accordance with Article 74(2) CACM, which requires the RDCTCS to “*include cost-sharing solutions for actions of cross-border relevance*”.
87. In light of the bottom-up decision-making process leading-up to ACER Decision’s 30/2020 (RDCTCS), the Board of Appeal concludes that, when carrying out its functions of regulatory supervision, ACER had to take account of the fact that All Core TSOs’ RDCTCS Proposal linked cost sharing of the RDCTCS to OS, whilst taking account of the views of All Core NRAs.

1.1.2 RAs in the zonal market model.

88. The EU has adopted a zonal electricity market design, which prioritizes *de facto* internal trade over CZ trade.
89. Hence, there is a need for CA and CM, as foreseen by the CACM, which includes “*the requirements for the establishment of common methodologies for determining the volumes of capacity simultaneously available between bidding zones, criteria to assess efficiency and a review process for defining bidding zones*” (Article 1(1) CACM).
90. There is a variety of CACM measures. RAs are short-term CACM measures. BZ reconfiguration or network infrastructure investments are mid-term or long-term measures. The more remote from the time of delivery the choice of a CACM measure needs to be made, the more CACM measures are available.
91. RAs are short-term preventive or corrective CM measures to maintain OS, as a result of an operational planning process, and are necessarily preceded by OSA. They can be costly or non-costly. The ER favours the use of non-costly RAs.
92. RDCTs are costly.
93. RDs consist of the alteration of the generation and/or load pattern in order to change physical flows in the transmission system and relieve a physical congestion (Article 2(26) ER).
94. CTs consist of CZ exchange initiated by TSOs between 2 BZs to relieve physical congestion (Article 2(27)ER).
95. CACM aims at reaching an optimal balance between short-term and long-term measures, whilst avoiding undue discrimination and avoiding that internal congestions are pushed to the border. The EU applicable regulatory framework avoids “undue” discrimination because all

discrimination cannot be avoided in a zonal model. Hence the EU applicable legal framework allows, as regards CA, for an acceptable level of discrimination to be agreed upon in Core CCM (ACER Decision 02/2019).

96. Similarly, at cost sharing level, LFs, i.e. physical flows in one BZ caused by internal commercial transaction in another BZ, are unavoidable in a zonal model. Hence, the EU applicable legal framework allows, as regards CM, for an acceptable level of LFs to be agreed upon (ACER Decision 30/2020).
97. As set out above, the choice of CACM measures depends on the timing of this choice.
98. RAs are CM measures of last resort, as shown graphically below:

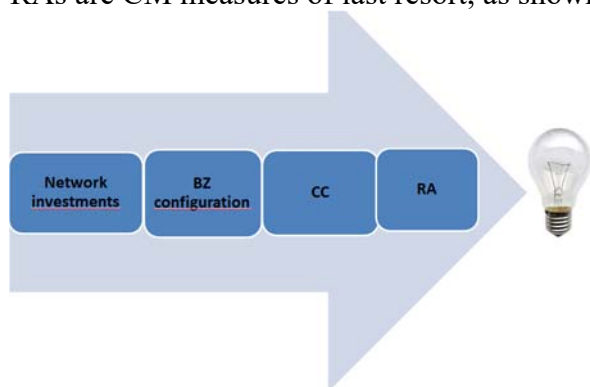

Source: Board of Appeal

99. Given this time sequence, RAs are an alternative for all other measures. However, the reverse is not true. In order to solve congestion close to delivery of electricity, network investments, BZ reconfigurations and CC cannot substitute RAs.

1.1.3 The need for coordination of RAs in Core CCR.

100. RAs can be coordinated or not coordinated.
101. The EU electricity regulatory framework requires a systematic coordination of potential RAs that are at least sometimes able to address violations of current limits on XNEs (“XRAs”). This coordination aims at replacing *ad hoc* bilateral or multilateral coordination by NRAs. Coordination of XRAs allows for the identification of the most effective and economically efficient XRAs to solve identified physical congestions and relieve OS violations, irrespective of whether the reasons for the physical congestion fall within or outside the TSOs’ control area.
102. The coordinated methodologies foreseen by the EU applicable regulatory framework identify the optimal CM measures, regardless of their cost.
103. The coordination of RAs is decided at EU level through the CSAM (ACER Decision 07/2019) and CGMM-v3 (a precondition for CCC and CROSA).
104. The CROSA is a process of OS analysis performed in accordance with Article 78 SO, which requires TSOs to involve Regional Security Coordinators (“RSCs”).

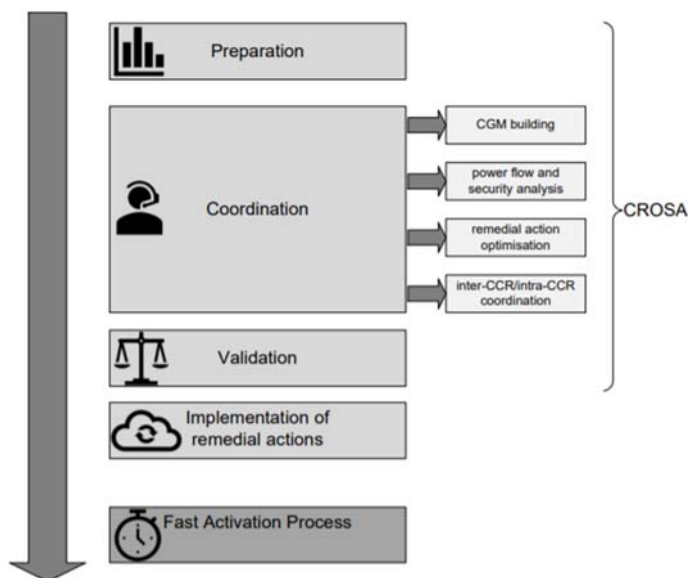
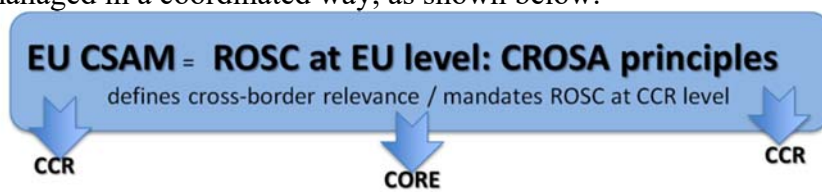

Figure 1: Overview Coordinated Regional Operational Security Assessment (CROSA)

process

Source: ENTSO-E Explanatory Document to the Core CCR ROSC in accordance with Article 76 SO²².

105. At EU level, the CSAM requires an identification of NEs where OS violations need to be managed in a coordinated way, as shown below.



Source: Board of Appeal.

106. The EU applicable regulatory framework foresees coordinated methodologies to identify the optimal CM measures, regardless of their cost. A correct scope of the methodologies is therefore key, as it impacts *a priori* the choice of the most optimal CM measure and, hence, the essence of CM.

107. The need for coordination and harmonisation of RDCTCS processes in Core CCR has been set out in All Core TSOs' Report assessing the progressive coordination and harmonisation of mechanisms and agreements for RDCT in accordance with article 35(3) CACM²³. It states that, generally, the agreements and mechanisms used for RDCT "are national, and they are often quite different due to historical reasons." "Except within the TSC cooperation covering a part of the CCR, there is currently **no** regional cost-sharing methodology (polluter-pays or socialisation of costs) in place. The cost-sharing agreements are highly dependent on the specific border/contract between TSOs. Most of the time, the "requester pays" principle is applied, meaning that the TSO with the congestion has to cover the costs of the remedial actions needed to relieve it. Some bilateral agreements exist between TSOs, in those cases, socialization of costs is applied for specific congestions." (emphasis added).

108. Said report also states the following: "Coordinating the use of RAs at regional level to avoid unnecessary distortions and improve the global social welfare. An **improved coordination of RDCT measures** should be considered as an **essential step towards the optimization of the actions taken by TSOs to effectively relieve physical congestions, limit congestion management costs and maximize the cross-border capacity made**

²² Annex 22 to the Defence.

²³ <https://eepublicdownloads.entsoe.eu/clean-documents/Network%20codes%20documents/Implementation/ccr/methodologies/core/cacm-deliverables/coordinated-rd-and-ct-art-35/20190117-core-tsos-consultation-report-harmonisation-final.pdf>

available to the market. This is especially the case for CORE region, as the application of the “20% minRAM rule” in the FB CCM recently approved within CWE, already extends the number of cases where RDCT measures are necessary. It is therefore regrettable that TSOs have considered this report as a mere formal exercise in order to strictly meet CACM deadline (26 months after CCRs approval) and did not take the opportunity to conduct an in-depth analysis of current practices to assess potential solutions to move towards a progressive coordination and harmonisation of current mechanisms and agreements for RDCT. One Market Party considers that the report should not only list the current practices already in place, but should also take this opportunity to assess the underlying reasons why TSOs have decided to rely on CT and/or RD and/or non-costly remedial actions only. It would highlight whether diverging TSOs practices are due to historical reasons, different network structures and/or market designs. Such an assessment would also provide good guidance for defining the adequate level of harmonization needed.” (emphasis added).

109. This need for coordination of XRAs in the Core CCR was also stressed in the responses to the public consultation leading-up to ACER Decision 35/2020 and the Contested Decision respectively on the RDCT and ROSC²⁴.

1.1.4 Operational security in EU electricity regulation.

110. The Board of Appeal observes that the differentiation, alleged by Appellant I, between material processes to ensure OS, governed by SO, on the one hand, and material processes enabling CB trade, governed by CACM, on the other hand, is incorrect.

111. It is not only the SO that relates to OS. The objectives of the CACM and the ER are the integration of the European electricity market through a harmonised framework for CB exchanges of electricity, whilst ensuring OS.

112. Recital (2) ER states: *“The Energy Union aims to provide final customers – household and business – with **safe, secure, sustainable, competitive and affordable energy.**”* (emphasis added).

113. Recital (20) and (21) ER states: *“(20) When regional coordination centres carry out a capacity calculation, they should maximise capacity considering non-costly remedial actions and respecting the operational security limits of transmission system operators in the Capacity Calculation Region. Where the calculation does not result in capacity equal to or above the minimum capacities set out in this Regulation, regional coordination centres should consider all available costly remedial actions to further increase capacity up to the minimum capacities, including redispatching potential within and between the capacity calculation regions, **while respecting the operational security limits** of transmission system operators of the Capacity Calculation Regions. Transmission system operators should report accurately and transparently on all aspects of capacity calculation in accordance with this Regulation and should ensure that all information sent to regional coordination centres is accurate and fit for purpose. (21) When performing capacity calculation, regional coordination centres should calculate cross-zonal capacities using data from transmission system operators **which respects the operational security limits** of the transmission system operators' respective control areas. Transmission system operators should be able to deviate from coordinated capacity calculation where its implementation would result in a **violation of the operational security limits of network elements** in their control area. Those deviations should be carefully monitored and transparently reported to prevent abuse and ensure that the volume of interconnection capacity to be made available to market participants is not limited in order to solve congestion inside a bidding zone. Where an action plan is in place, the action plan should take account of deviations and address their cause.”* (emphasis added).

114. Article 1(1) ER states that the ER aims to *“(a) set the basis for an efficient achievement of the objectives of the Energy Union and in particular the climate and energy framework for 2030 by enabling market signals to be delivered for increased efficiency, higher share of renewable energy sources, **security of supply**, flexibility, sustainability, decarbonisation and innovation”; and “(d) facilitate the emergence of a well-functioning and transparent wholesale market, contributing to **a high level of security of electricity supply**, and provide for mechanisms to harmonise the rules for cross-border exchanges in electricity”.* (emphasis added).

115. Recitals (1) and (2) CACM state *“(1) The urgent completion of a fully functioning and interconnected internal energy market is crucial to the **objectives of maintaining security of energy supply**, increasing*

²⁴ Annex II to ACER Decision 35/2020 and Annex II to the Contested Decision;
https://acer.europa.eu/Official_documents/Acts_of_the_Agency/Individual%20decisions%20Annexes/ACER%20Decision%20No%202033-2020_Annexes/ACER%20Decision%202033-2020%20on%20Core%20ROSC%20-%20Annex%20II.pdf

competitiveness and ensuring that all consumers can purchase energy at affordable prices. A well-functioning internal market in electricity should provide producers with appropriate incentives for investing in new power generation, including in electricity from renewable energy sources, paying special attention to the most isolated Member States and regions in the Union's energy market. A well-functioning market should also provide consumers with adequate measures to promote more efficient use of energy, which presupposes a secure supply of energy. (2) **Security of energy supply** is an essential element of public security and is therefore inherently connected to the efficient functioning of the internal market in electricity and the integration of the isolated electricity markets of Member States. Electricity can reach the citizens of the Union only through the network. Functioning electricity markets and, in particular, the networks and other assets associated with electricity supply are essential to public security, to economic competitiveness and to the well-being of the citizens of the Union.” (emphasis added)

116. Article 3 CACM states that the objectives of CACM cooperation include “(c) ensuring operational security”.
117. Turning to the provisions that apply to RDCT and RDCTCS, they are intrinsically linked to OS.
118. Article 35 CACM, which mandates the creation of the RDCT, stipulates in Article 35(4) CACM: “Each TSO shall abstain from unilateral or uncoordinated redispatching and countertrading measures of cross-border relevance. Each TSO shall coordinate the use of redispatching and countertrading resources **taking into account their impact on operational security** and economic efficiency.” (emphasis added)
119. Article 74 CACM, which mandates the creation of the RDCTCS requires in Article 74(5) CACM that the RDCTCS includes “(c) a mechanism to assess the impact of the remedial actions, **based on operational security and economic criteria**” (emphasis added).
120. The 74 CACM requires the RDCTCS to be consistent with the general CM principles of Article 16 ER. Article 16 ER, which sets out the general principles CA and CM, highlights the importance of OS in (i) Article 16(3) (“Regional coordination centres shall calculate cross-zonal capacities **respecting operational security limits** using data from transmission system operators including data on the technical availability of remedial actions, not including load shedding. Where regional coordination centres conclude that those available remedial actions in the capacity calculation region or between capacity calculation regions are not sufficient to reach the linear trajectory pursuant to Article 15(2) or the minimum capacities provided for in paragraph 8 of this Article **while respecting operational security limits**, they may, as a measure of last resort, set out coordinated actions reducing the cross-zonal capacities accordingly. Transmission system operators may deviate from coordinated actions in respect of coordinated capacity calculation and **coordinated security analysis** only in accordance with Article 42(2).”;(ii) Article 16(8) and (9) ((..) a) for borders using a coordinated net transmission capacity approach, the minimum capacity shall be 70 % of the transmission capacity **respecting operational security limits** after deduction of contingencies, as determined in accordance with the capacity allocation and congestion management guideline adopted on the basis of Article 18(5) of Regulation (EC) No 714/2009, (b) for borders using a flow-based approach, the minimum capacity shall be a margin set in the capacity calculation process as available for flows induced by cross-zonal exchange. The margin shall be 70 % of the capacity **respecting operational security limits** of internal and cross-zonal critical network elements, taking into account contingencies, as determined in accordance with the capacity allocation and congestion management guideline adopted on the basis of Article 18(5) of Regulation (EC) No 714/2009. 9. At the request of the transmission system operators in a capacity calculation region, the relevant regulatory authorities may grant a derogation from paragraph 8 on foreseeable grounds **where necessary for maintaining operational security**. Such derogations, which shall not relate to the curtailment of capacities already allocated pursuant to paragraph 2, shall be granted for no more than one-year at a time, or, provided that the extent of the derogation decreases significantly after the first year, up to a maximum of two years. The extent of such derogations shall be strictly limited to what is necessary **to maintain operational security** and they shall avoid discrimination between internal and cross-zonal exchanges.”) and (iii) Article 16(11) “As far as technically possible, transmission system operators shall net the capacity requirements of any power flows in opposite directions over the congested interconnection line in order to use that line to its maximum capacity. **Having full regard to network security**, transactions that relieve the congestion shall not be refused.” (emphasis added).

1.1.5 EU electricity regulation links the RDCTCS, RDCT and ROSC methodologies.

121. The applicable regulatory framework, to be found in the CACM and SO, links all 3 Core methodologies, whilst referring at the same time to the EU CSAM:

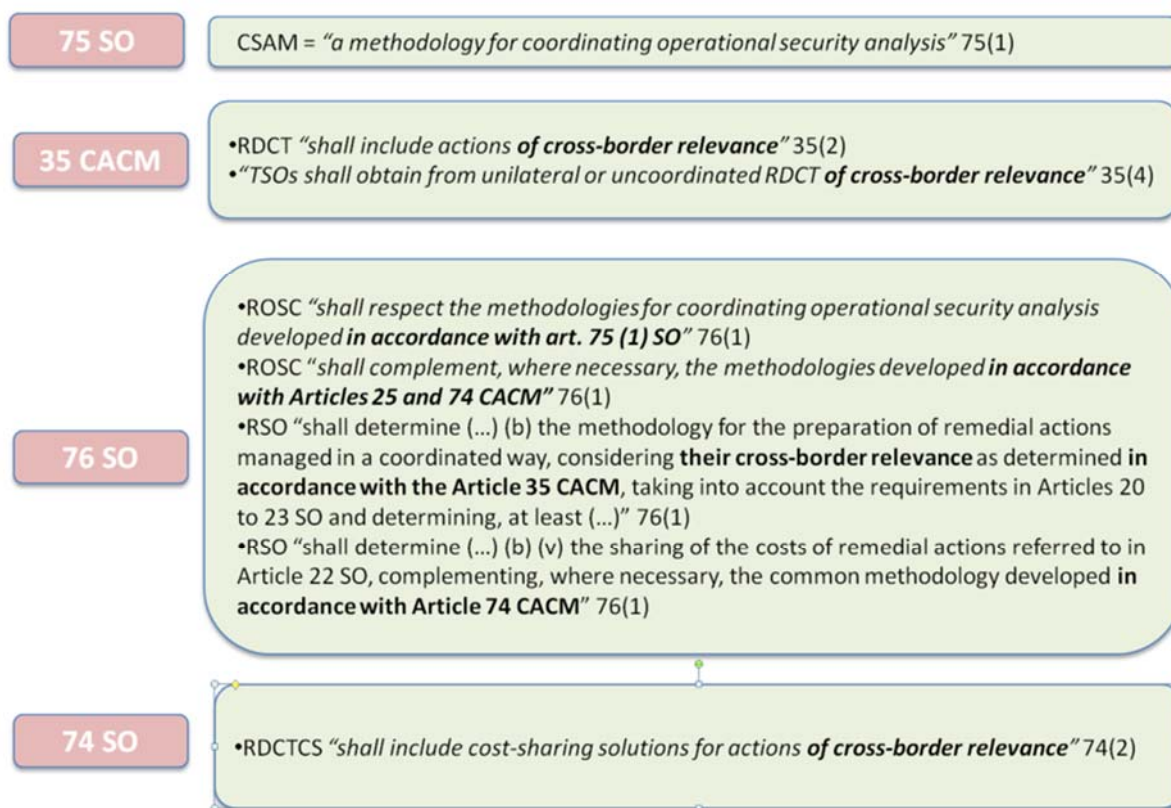

Source: Board of Appeal

122. All Core NRAs have expressly recognised this link in their Non-Paper on All TSOs’ ROSC: “Core NRAs agree that the ROSC proposal and the RDCT methodologies are interlinked and describe complementary processes. For instance, the methodology following Article 35 of the CACM Regulation and the ROSC methodology both describe the coordination of redispatching and countertrading. Network elements which are eligible for cost sharing according to Article 74 of the CACM Regulation must also be defined within the ROSC methodology. Core NRAs acknowledge the utmost importance of harmonization and consistency between these methodologies. It was therefore agreed, that such consistency would be best addressed in case the methodologies were dealt with together”²⁵.

1.1.6 All 3 methodologies have duly been linked.

123. At EU level, the CSAM requires an identification of NEs where OS violations need to be managed in a coordinated way. The interaction between the methodologies at EU level and the methodologies at Core level is depicted as follows:

²⁵ <https://www.acer.europa.eu/en/Electricity/OPERATION-CODES/SYSTEM-OPERATION/Documents/Core%20Non-Paper%20on%20ROSC.pdf>

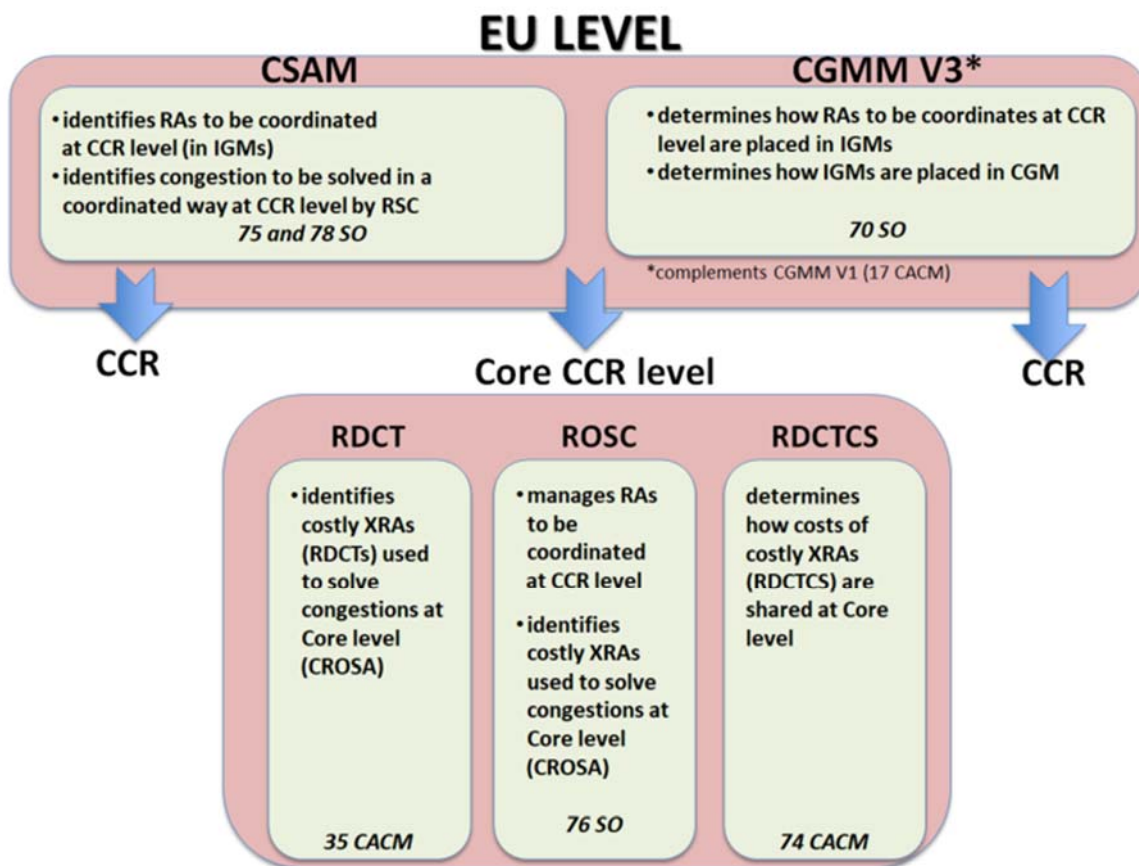

Source: Board of Appeal.

124. The applicable regulatory framework provides for cross-references between the methodologies at EU level and CCR level, which need to comply with the general CM principles of Article 16 ER, as depicted below:

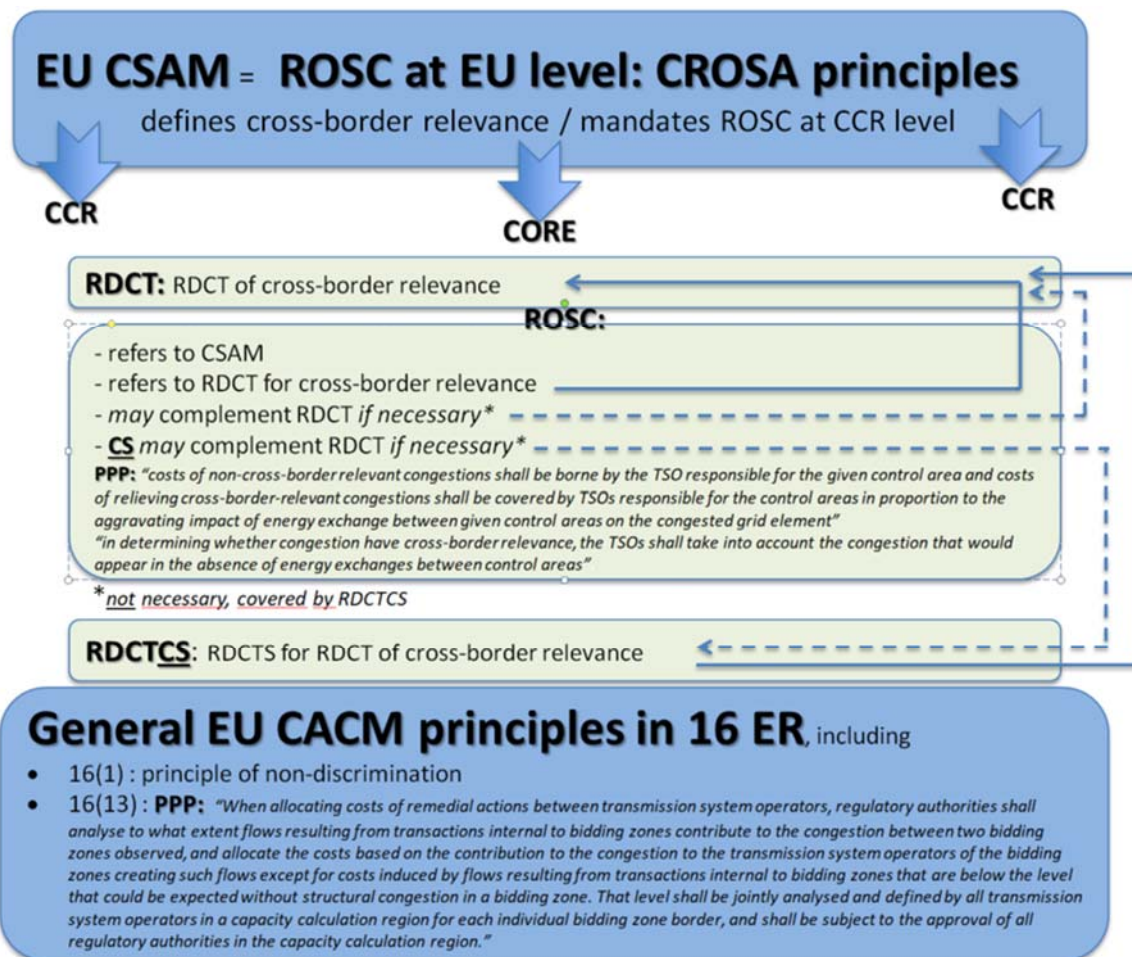

Source: Board of Appeal.

125. Article 15 CSAM states that CROSA applies to "CB relevant NEs" or XNEs.
126. It defines these XNEs as "CNEs and other NEs above a voltage level defined by TSOs, except for those elements for which all TSOs in a CCR agree that they are not cross-border relevant for the concerned CCR and may therefore be excluded".
127. As set out in paragraph 70 of ACER Decision 07/2019 on the CSAM, some NEs that are not CNEs may still be XNEs, for example when they are significantly impacted by LFs from neighbouring BZs. It states: "To address this problem, the Agency is of the opinion that the **notion of cross-border relevance should include all network elements where the percentage of flows resulting from exchanges outside the TSO control area where such network element is located is significant**. As such, this principle requires deeper analyses by TSOs in a CCR. Therefore, the Agency replaced the proposed principle (i.e. at least critical network elements) with a more comprehensive high level principle to harmonise the identification of cross-border relevant network elements across CCRs. The latter should result in the cross-border relevant network elements to **comprise all network elements above certain voltage level except those network elements for which all TSOs in a CCR agree that they are not cross-border relevant**. The Agency also understands that including too many network elements in the coordination does not risk a loss of economic efficiency or operational security in regional coordination. However, including not enough network elements would indeed entail such risk. For this reason, the principle for the identification of cross-border relevant network elements as proposed by the Agency is considered as adequate." (emphasis added).
128. The test of the CSAM is cross-border relevance. Cross-border relevance of NEs involves the mutual interdependency of such NEs and RAs by laws of physics.
129. The CSAM applies since 2020. Once the CSAM has decided at EU level which RAs have to be coordinated, the CACM mandates a bottom-up decision-making process for the RDCT,

ROSC and RDCTCS at Core CCR level. These processes were finalised by ACER Decision 35/2020 (RDCT), the Contested Decision and ACER Decision 30/2020.

130. Consequently, at Core level, both the ROSC and the RDCT had to apply the CROSA to XNEs as defined by CSAM, i.e. (i) CNEs and (ii) NEs over a voltage level to be determined by All Core TSOs. All Core TSOs determined said voltage level at 220 kV. The scope implies that XNEs can be CB NEs or internal NEs, as long as they are CB relevant.
131. Under the CROSA process, the optimised and coordinated RDCT actions aim to relieve physical congestion on all XNEs (i.e. CNEs and NEs \geq 220 kV), irrespective of whether the reasons for the physical congestion fall inside or outside the TSOs' control area.
132. One of the purposes of managing OS violations on a set of NEs in a co-ordinated way is to ensure that full account is taken of the consequences of RAs on one NE for other interacting NEs. Failure to do so may impact OS. As stated in Recital (12) of the Contested Decision's ROSC, the Core CCR is characterised by a highly meshed network, and at 220kV or above, it is not possible to identify a NE that would be impacted only by remedial actions that do not have any impact on other elements. Also, RAs are, as set out above in Sub-Plea 1.1.2, CM measures of last resort. Hence, a restrictive approach as to the NEs to include in its scope would imply that there would remain no alternative solution to solve congestions on the excluded NEs, threatening OS.
133. As expressly set out in paragraph 133 of the Contested Decision, the threshold of \geq 220 kV was set in accordance with the PPP articulated in Article 76 SO, taking into account the structural congestion that would appear in the absence of energy exchanges. This threshold implies that, in the absence of energy exchanges, NEs \geq 220 kV would not be congested and are thus XNEs. When setting the limit of 220 kV, ACER duly reproduced Article 5(1) of All Core TSOs' ROSC Proposal, in which All Core TSOs stated that "network elements in the Core CCR with a voltage level higher or equal to 220 kV" would be "subject to CROSA, on which operational security limits violations need to be managed in a coordinated way"²⁶.
134. The Explanatory Document to All Core TSOs' ROSC Proposal clearly delineates the scope for XNEs as follows²⁷:

"The following figure 2 shows which elements (highlighted in yellow) can be discarded from the set of secured elements in accordance with the provisions explained above:

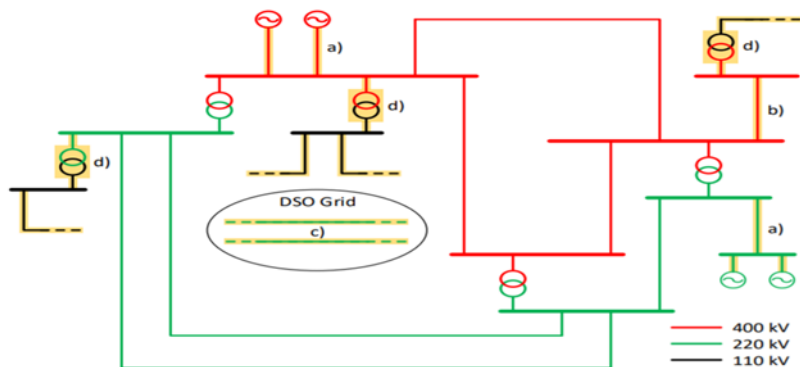

Figure 2: Elements (highlighted in yellow) which can be discarded from the set of Core XNEs

In addition to these criteria, any element can be discarded from the set of secured elements, when a common agreement among Core TSOs is reached. This could be the case, if a part of the grid is almost not influenced trans-regionally. However, such a rule cannot be applied to the Critical Network Elements in accordance with Article 5 of day-ahead and intraday capacity calculation methodology of the Core CCR and XBRNEs in accordance with the Core RD and CT methodology."

²⁶https://eepublicdownloads.entsoe.eu/clean-documents/nc-tasks/EBGL/SO_GL_A76_CORE_CCR_ROSC%20Methodology.pdf

²⁷ Annex 22 to the Defence, p. 9.

Source: Explanatory Document to All Core TSOs' ROSC Proposal (emphasis added).

135. Hence, the scope of the ROSC and RDCT of CNEs and NEs ≥ 220 kV has correctly been set in accordance with CSAM. Both the RDCT and ROSC have an identical scope because they both apply CROSA. Under the CROSA process, the optimised and coordinated RDCT actions aim to relieve physical congestion on all XNEs, irrespective of whether the reasons for the physical congestion falls inside or outside TSOs' control area (i.e. CNEs and NEs ≥ 220 kV).
136. The Explanatory Document to All Core TSOs' ROSC Proposal clearly explained that the scope of XNEs would be wider than CNEs and graphically depicted as follows²⁸:

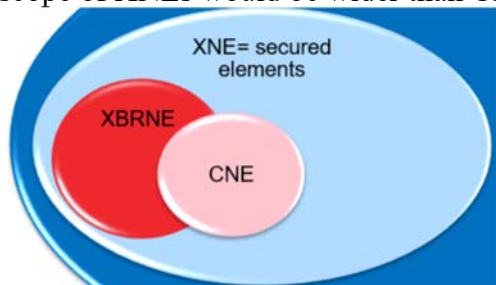

Source: Explanatory Document to All Core TSOs' ROSC Proposal.

137. ACER correctly determined that the scope of the RDCTCS had to match the scope of the ROSC and RDCT. The RDCT and ROSC need a cost sharing mechanism in order to be implemented because of their very nature: when optimising RA coordination, RDCT and ROSC aim at minimising costs deriving from RAs. Regional RA coordination can only occur if an adequate cost sharing ensues and, *vice versa*, cost sharing of RAs can only occur once the RAs have taken place. This is duly illustrated by ACER in paragraph 167 of the Contested Decision: “For example, a congestion on the border between Germany and Poland may be most efficiently resolved by involving downward redispatching of generating unit(s) in Germany and upward redispatching of generating unit(s) in Czech Republic. It is expected that this redispatching actions will involve some revenues for German TSOs and some costs for the Czech TSO. Naturally, the Czech TSO will only be willing to support solving the congestion on the border between Germany and Poland if the incurred costs will be shared with all involved TSOs based on the polluter-pays principle. It is thus impossible to expect that TSOs can fully coordinate remedial actions at regional level without having the certainty that the corresponding costs will be shared among all TSOs.”
138. The Board of Appeal finds that the scope of the ROSC, RDCT and RDCTCS has correctly been defined by the Contested Decision, ACER Decision 35/2020 and ACER Decision 30/2020.

1.1.7 The RDCTCS is in line with the CACM, the ER and the PPP.

139. As set out above, the RDCTCS scope has correctly been set as including XNEs in accordance with the ROSC and RDCT at Core level and CSAM at EU level.
140. The Board of Appeal finds that removing internal XNEs or another subset of XNEs would lead the RDCTCS to infringe Article 74(2) CACM, which requires that the RDCTCS applies to XNEs, including both CB XNEs and internal XNEs, to the extent that they are CB relevant (i.e. CNEs or NEs ≥ 220 kV).
141. Indeed, the removal of a subset of XNEs from the scope of the RDCTCS - beyond the exceptions foreseen by the scope of the RDCTCS, i.e. the exceptions foreseen for (i) NEs < 220 kV; (ii) NEs that are not CNEs and are radial lines, distribution NEs, transformers with secondary voltage < 220 kV or commonly agreed upon by All Core TSOs and (iii) XNEs that

²⁸ Annex 22 to the Defence, p. 10. All Core TSOs' ROSC Proposal differentiated between secured NEs and scanned NEs. Secured NEs correspond with XNEs. Scanned NEs are NEs monitored during CROSA such that CROSA does not worsen, or create new OS violations (see Article 2(s) of the Contested Decision's ROSC).

are part of another CCR CROSA, for TSOs belonging to more than one CCR - would lead to non-compliance with the requirements of Article 74 CACM, which is the legal basis on which the RDCTCS is adopted.

142. A removal of a subset of XNEs from the scope of the RDCTCS would not only infringe Article 74(2) CACM, but also annihilate the very concept of cost-sharing pursuant to RA coordination. Sharing a cake after having severed part of it does not amount to sharing.
143. It would, furthermore, not only undermine cost sharing under the RDCTCS, but also undermine a correct functioning of the ROSC and RDCT and even negatively affect efficient CACM all in all in the Core CCR. It would negatively affect RA coordination in Core CCR because, as already set out above, regional RA coordination can only occur if an adequate cost sharing is put in place. It would counter the CSAM and disrupt the CROSA process at CORE level, set about above in Sub-pleas 1.1.5 and 1.1.6.
144. Put in a broader context, it would negatively affect an efficient CACM in Core CCR because according to the CCM (ACER Decision 02/2019), Core TSOs are under an obligation to continuously monitor and identify the most efficient CM method for congestions on internal XNEs, e.g. CC, RAs, BZ reconfiguration or network investments (see Sub-plea 1.1.2 above) and their decision to address congestions with RAs depends on the coordination of RAs and related cost-sharing. In the absence of cost sharing for specific congested XNEs, RAs could no longer be considered as an alternative CM method for those XNEs. This would automatically prevent efficient CM as required by Article 16(1) ER. CCM and CROSA need to be fully integrated as both are measure foreseen by CACM. Through the identification of the most effective CM measures, CACM aims at maximising CZC and ensuring OS.
145. Not applying the RDCTCS to all XNEs would infringe Article 74(2) CACM, which expressly requires the RDCTCS to provide cost sharing solutions for actions “*of cross-border relevance*”, i.e. CNEs or NEs ≥ 220 kV (in line with CSAM, RDCT and ROSC as set out above in Sub-pleas 1.1.5 and 1.1.6). Indeed, cross-border relevance of NEs involves the mutual interdependency of such NEs and RAs by laws of physics. If XNEs are excluded, the excluded XNEs would, therefore, still be impacted by RA activation on included XNEs, with likely negative OS consequences. The erroneous exclusion of XNEs from the CROSA scope would have as a consequence that physical congestion would not be relieved on the excluded XNEs and would threaten OS on those XNEs.
146. Under the CROSA process, the optimised and coordinated RAs aim to relieve physical congestion on all XNEs (i.e. CNEs and NEs ≥ 220 kV), irrespective of whether the reasons for the physical congestion fall inside or outside the TSOs’ control area. For example, an exclusion of internal XNEs would infringe Article 74(2) CACM because internal XNEs owned by a TSO could be congested by (i) LFs from neighbouring BZs, not caused CB trade or (ii) RAs taken in BZs of other TSOs. Such internal XNEs should therefore be eligible for cost sharing.
147. As set out above in Sub-plea 1.1.2, impeding the inclusion of some NEs in costly RAs whilst overly extending CC to NEs may affect the optimal CM choice (a choice could be made for CC even it would not prove to be the economically most efficient means to address congestion). RAs are CM measures of last resort, close to real time. Hence, a restrictive approach as to the XNEs to include in its scope would imply that there would remain no alternative solution to solve congestions on the excluded XNEs, threatening OS. Moreover, the exclusion of XNEs from RAO would not only maintain but even worsen OS issues in relation to these NEs. Given that these NEs have cross-border relevance, they are impacted by RAs activated to solve violations on included XNEs. Wrongfully excluding such XNEs from the scope would not be able to eliminate their intrinsic cross-border nature.

148. Excluding some XNEs from the scope of the RDCTCS would also introduce a serious element of discrimination. This would be contrary to Article 74(6)(i) CACM, which requires the RDCTCS to “(i) comply with the principles of transparency and non-discrimination.”, Article 3(e) CACM containing the CACM objective of “ensuring fair and non-discriminatory treatment of TSOs, NEMOs, the Agency, regulatory authorities and market participants” and the general principle of CA and CM of Article 16(1) ER, which states that “Network congestion problems shall be addressed with non-discriminatory market-based solutions which give efficient economic signals to the market participants and transmission system operators involved. Network congestion problems shall be solved by means of non-transaction-based methods, namely methods that do not involve a selection between the contracts of individual market participants. When taking operational measures to ensure that its transmission system remains in the normal state, the transmission system operator shall take into account the effect of those measures on neighbouring control areas and coordinate such measures with other affected transmission system operators as provided for in Regulation (EU) 2015/1222.”
149. According to ACER, as per its Rejoinder and statements at the Oral Hearing, the infringement of the principle of non-discrimination is key in determining the correct RDCTCS scope. The Intervener supports this stance. It alleges that the exclusion of a subset of XNEs from the RDCTCS although these XNEs are included in the ROSC (optimisation through CROSA) would lead to an unjustified discrimination²⁹. Disregarding LFs on some XNEs would be similar to determining an infinite legitimate LF threshold on those XNEs, applying a full OPP to these XNEs and carrying out a hidden transfer of costs from TSOs in BZs generating LFs towards TSOs in BZs hosting LFs that own the excluded XNEs.
150. As a consequence, applying the RDCTCS only to a part of its scope would also infringe Article 74(6)(f) CACM, which requires that it should “facilitate adherence to the general principles of congestion management as set out in Article 16 of Regulation (EC) No. 714/2009” because these general principles also include Article 16(1) ER. According to settled case-law, any EU provision needs to be interpreted in compliance with the principle of non-discrimination³⁰.
151. The removal of a subset of XNEs from the scope of the RDCTCS would also be contrary to Article 74(6)(b) CACM, which requires the RDCTCS to “(b) be consistent with the responsibilities and liabilities of the TSOs involved” because All Core TSOs would be infringing their obligations under Article 74 CACM and 16 ER when failing to apply a cost sharing solution to all XNEs.
152. In the same line, the removal of a subset of XNEs from the scope of the RDCTCS would be contrary to Article 74(6)(c) CACM, which requires the RDCTCS to “(c) ensure a fair distribution of costs and benefits between the TSOs involved”. It suffices to indicate that, due to the discriminatory treatment between TSOs that own internal XNEs and TSOs that own CB XNEs or interconnectors (assuming that this is the distinction meant by “congestions between two bidding zones observed”), the cost sharing solution provided by the RDCTCS would not be fair if not applied to its full scope of XNEs.
153. Removing a subset of XNEs from the scope of the RDCTCS would imply that, on the one hand, LF-causing TSOs would not have to pay the costs although they did not sufficiently invest in their electricity network or did not change their BZ configuration in order to reduce LFs that pollute internal XNEs owned by LF-hosting TSOs whereas, on the other hand, LF-hosting TSOs would have to bear those costs.
154. Moreover, if the RDCTCS were only to be applied to interconnectors, this would lead to the unfair situation that a TSO facing congestion on a BZB due to LFs would be entitled to cost sharing whereas a TSO facing congestion on other XNEs, not on a BZB, would not be entitled to cost sharing.

²⁹ Application for Intervention by the Intervener.

³⁰ Cases C-402/07 and C-432/07, *Sturgeon v Condor*, ECLI:EU:C:2009:716, para 48.

155. Not applying the RDCTCS to some XNEs would also be contrary to Article 74(6)(a) CACM, which requires the RDCTCS to “provide incentives to manage congestion, including remedial actions and incentives to invest effectively”. It would not provide the correct incentives to Core TSOs. LF-causing TSOs would not receive the correct incentives to take the necessary measure to reduce their LFs below the legitimate LF threshold, e.g. through investments in network upgrades. Furthermore, as set out by ACER in its Defence, solving LFs on LF-causing XNEs is a prerequisite for LF-causing TSOs in order to solve problems of IFs causing internal congestion.
156. Finally, narrowing the scope of the RDCTCS would infringe Article 74(6)(e) CACM, which requires the RDCTCS to “(e) facilitate the efficient long-term development and operation of the pan-European interconnected system and the efficient operation of the pan-European electricity market”. As set out above, it would not only obliterate cost sharing under the RDCTCS, but also undermine a correct functioning of the ROSC and RDCT and negatively affect efficient overall CACM in the Core CCR.
157. The Board of Appeal finds that the scope of the RDCTCS neither infringes Article 16(13) ER nor the PPP.
158. Article 74(6)(f) CACM requires the RDCTCS to “facilitate adherence to the general principles of congestion management as set out in Article 16 of Regulation (EC) No 714/2009.”
159. Regulation (EC) 714/2009 is the Old ER. Point 1.7 of Annex 1 to the Old ER contained CM principles: “When defining appropriate network areas in and between which congestion management is to apply, TSOs shall be guided by the principles of cost-effectiveness and minimisation of negative impacts on the internal market in electricity. Specifically, TSOs shall not limit interconnection capacity in order to solve congestion inside their own control area, save for the abovementioned reasons and reasons of operational security. If such a situation occurs, this shall be described and transparently presented by the TSOs to all the system users. Such a situation shall be tolerated only until a long-term solution is found. The methodology and projects for achieving the long-term solution shall be described and transparently presented by the TSOs to all the system users.”
160. ACER’s Recommendation 02/2016 on the common capacity calculation and redispatching and countertrading cost sharing methodologies (“**ACER Recommendation 02/2016**”) set out principles, including the PPP. ACER Recommendation 02/2016³¹ stipulated: “the costs of remedial actions are most often paid by the TSOs facing congestion problems (i.e. requester-pays principle) rather than the ones causing them (i.e. polluter-pays principle)”.
161. Recast ER (“**ER**”) has been adopted in the context of the Clean Energy Package, which introduces stricter and harmonised rules for capacity mechanisms (reconciling EU objectives of security of supply and emission reductions), enhances regional coordination in order to improve market functioning and competitiveness and fosters the completion of the internal electricity market. Since ER, Article 74(6)(f) CACM has to be understood as facilitating adherence to the general principles of CM of the ER instead of the Old ER (see Article 70 ER: “Regulation (EC) No 714/2009 is repealed. References to the repealed Regulation shall be construed as references to this Regulation and shall be read in accordance with the correlation table set out in Annex III”).
162. Article 16(13) ER provides: “When allocating costs of remedial actions between transmission system operators, regulatory authorities shall analyse to what extent flows resulting from transactions internal to bidding zones contribute to the congestion between two bidding zones observed, and allocate the costs based on the contribution to the congestion to the transmission system operators of the bidding zones creating such flows except for costs induced by flows resulting from transactions internal to bidding zones that are below the level that could be expected without structural congestion in a bidding zone. That level shall be jointly analysed and defined by all transmission system operators in a capacity calculation region for each individual bidding zone border, and shall be subject to the approval of all regulatory authorities in the capacity calculation region.”

31

http://www.acer.europa.eu/Official_documents/Acts_of_the_Agency/Recommendations/ACER%20Recommendation%2002-2016.pdf

163. Article 16(13) ER reflects the PPP: it mandates regulatory authorities to identify the cause of the congestions and mandates TSOs, upon regulatory supervision, to determine a threshold in order to allocate costs to TSOs that are causing polluting flows above the threshold.
164. According to Article 16(13) ER, the origins of physical flows that are contributing to the congestions on XNEs need to be identified.
165. Accordingly, ACER Decision 30/2020's RDCTCS first maps XRA costs to XNECs (Article 5 of ACER Decision 30/2020's RDCTCS) and then distributes the costs on XNECs to Core TSOs (Article 7 of ACER Decision 30/2020's RDCTCS).
166. Article 16(13) ER requires that the physical flows resulting from electricity exchanges or transactions internal to BZs - i.e. IFs and LFs - should be identified as contributors to the congestion. It further requires that, when allocating costs, the ensuing cost sharing methodology allocates them to TSOs of the BZs causing such flow, based on the contribution to the congestion to TSOs of BZs. In case of CZ XNEs, these flows are LFs, whereas in case of internal XNEs, these flows are IFs and LFs (IFs caused by electricity exchanges within the BZ where the XNE is located and LFs caused by electricity exchanges within other BZs). As will be set out below in the Second Consolidated Plea, LFs should be identified as the primary contributors to the congestion on internal XNEs, whereas IFs should be penalised only for the remaining volume of the congestion.
167. Accordingly, ACER Decision 30/2020's RDCTCS correctly decomposes the different types of flows on each XNEC in order to identify IFs and LFs (Article 6 of ACER Decision 30/2020's RDCTCS) and sets a *de minimis* threshold for LFs and not for IFs (Article 7(3) and (4) of ACER Decision 30/2020's RDCTCS). The OPP applies to IFs and LFs below the threshold, whereas the PPP applies to LFs above the threshold. The legitimate LF threshold is a temporary legitimate LF threshold which will automatically be replaced by a definitive legitimate LF threshold as soon as All Core TSOs agree upon such threshold and upon approval of All Core NRAs (see, Third Consolidated Plea). Furthermore, LFs above the threshold are prioritised in the prioritisation of flows when distributing costs. Article 7(6) of ACER Decision 30/2020's RDCTCS states that costs of LFs above the threshold come first in the prioritisation and will be attributed to the TSO causing the LF (Article 7(6)(a) of ACER Decision 30/2020's RDCTCS). Costs of IFs come second in the prioritisation and will be attributed to the TSOs XNE connecting TSO (Article 7(6)(b) of ACER Decision 30/2020's RDCTCS). The rest of the flows will come third and also be attributed to the XNE connecting TSO (Article 7(c) of ACER Decision 30/2020's RDCTCS).
168. Appellant I argues that the textual wording of Article 16(13) ER, which requires that the PPP applies when costs are shared in relation to "*congestions between two bidding zones observed*", requires the RDCTCS to apply the PPP only to congestions "*between two bidding zones observed*". Appellant I claims that congestions "*between two bidding zones observed*" correspond with congestions on CB XNEs and that, consequently, the OPP applies to congestions on internal XNEs.
169. First, the textual wording of Article 16(13) ER does not limit the application of the PPP exclusively to congestions between 2 BZs. It does not impede the application of the PPP to other congestions than congestions between 2 BZs. It simply requires the application of the PPP to congestions between 2 BZs. A literal interpretation of Article 16(13) ER specifies the elements of a cost sharing solution for congestions between 2 BZs observed but it does not contain any prohibition regarding the adoption of a other cost sharing solutions.

170. Second, the application of the PPP to the full scope of the RDCTCS is confirmed by a contextual, teleological and historic interpretation, which requires the RDCTCS to apply the PPP to the full scope of XNEs³².
171. It is not conceivable that a general CACM principle, which merely states that the PPP should apply to cost sharing in relation to some types of congestion, would imply that polluting flows on CB XNEs or interconnectors (i.e. XNEs located on a BZB) would contribute to costs pursuant to the PPP, whereas polluting flows of the same type on internal XNEs would not contribute to costs pursuant to the PPP (assuming that this is the distinction meant by “congestions between two bidding zones observed”).
172. This would affect the RDCTCS scope in such a way that it would obliterate the entire package of CROSA-related methodologies in the Core region and, even worse, undermine efficient CM in Core CCR.
173. Analysing the provision’s legal context in a systematic manner, the removal of a subset of XNEs from the scope of the RDCTCS would be contrary to most requirements of Article 74 CACM, as set out above. That is why All Core TSOs’ RDCTCS Proposal duly linked the RDCTCS scope to OS (see above, Sub-Plea 1.1.1). Recital (35) ER reinforces the correct interpretation of Article 16(13) ER whereby TSOs causing polluting flows need to bear the costs, as opposed to TSOs hosting polluting flows. It states that TSOs have to be compensated for costs deriving from hosting CB flows on their NEs by the TSOs causing these flows: “*In an open, competitive market, transmission system operators should be compensated for costs incurred as a result of hosting cross-border flows of electricity on their networks by the operators of the transmission systems from which cross-border flows originate and the systems where those flows end.*”
174. Analysing the provision from a teleological angle³³, not defining the scope of the RDCTCS correctly as applying to all XNEs would go against the objectives of the CACM and the ER,. These goals are to maximise CZC and ensure OS through the identification of the most effective XRAs. As set out above, the removal of a sub-set of XNEs from the RDCTCS scope would undermine both regional coordination and efficient CM and could threaten OS in Core CCR.
175. Analysing the provision from a historical angle, ACER Recommendation 02/2016 set out principles, including the PPP. These principles were subsequently included in Point 1.7 of Annex I to the Old ER and have now been developed into a binding set of detailed provisions in Articles 15 and 16 of the ER. The fact that ACER Recommendation 02/2016 complained about the fact that TSOs hosting congestions instead of TSOs causing congestions pay the costs: “*the costs of remedial actions are most often paid by the TSOs facing congestion problems (i.e. requester-pays principle) rather than the ones causing them (i.e. polluter-pays principle)*”³⁴ reinforces the correct interpretation of Article 16(13) ER.

³² H.G. Schermes, D.F. Waelbroeck, “*Judicial Protection in the European Union*” (2001); N. Fennelly, “*Legal Interpretation at the European Court of Justice*”, Fordham International Law Journal Volume 20, Issue 3 1996; A. Albors Llorens, “*The European Court of Justice, More than a Teleological Court*”, Cambridge University Press, 2017;; Case 26/62 *Van Gend en Loos* ECLI:EU:C:1963:1; Case 6/64 *Costa v. ENEL* ECLI:EU:C:1964:66; Case 26/69 *Stauder v Ulm*, ECLI:EU:C:1969:57; Case 55/87 *Moksel v. BALM*, ECLI:EU:C:1988:377; Case C-89/81 *Hong Kong Trade*, ECLI:EU:C:1982:121; Case C-101/01 *Lindqvist* ECLI:EU:C:2003:596; Case C-409/06 *Winner Wette* ECLI:EU:C:2010:503; Case C-402/07 *Sturgeon and Others*, ECLI:EU:C:2009:716; Case C-439/08 *VEBIC* ECLI:EU:C:2010:739; Case C-41/09 *European Commission and Kingdom of the Netherlands*, ECLI:EU:C:2011:108; Joined Cases C-188/10 and C-189/10 *Melki and Abdeli* ECLI:EU:C:2010:363; Case C-583/11 *P Inuit Tapiriit Kanatami and Others*, ECLI:EU:C:2013:625.

³³ Board of Appeal Decisions A-004-2019 paras 106 and 158; A-001-2020, para 112 and A-002-2020, para 112.

³⁴

http://www.acer.europa.eu/Official_documents/Acts_of_the_Agency/Recommendations/ACER%20Recommendation%2002-2016.pdf

176. ACER did not exceed its competence when determining the RDCTCS scope and did not amend the scope of Article 16(13) ER or Article 74 CACM.
177. Appellant I claims that the RDCTCS scope infringes the PPP articulated in Article 76 SO. However, the PPP articulated in Article 76 SO, depicted above in the graph of Sub-Plea 1.1.6, is in accordance with the general PPP.
178. At the Oral Hearing, Appellant I clarified that it agrees with ACER that there should be a cost distribution for RAs activated under the CROSA governed by the ROSC and RDCT and that this cost distribution is correctly included in the mapping process of Decision 30/2020 (RDCTCS). Appellant I alleged that, according to Article 76 SO, cost sharing under ROSC complements the RDCTCS and that costs of non-XNEs congestions should be borne by the TSO responsible for the control area and costs of relieving XNEs should be borne by the TSO responsible for the control area in proportion to the aggravating impact of energy exchanges between given control areas on the congested NE.
179. The PPP of Article 76 SO states: *“1. Costs of non-cross-border relevant congestions shall be borne by the TSO responsible for the given control area and costs of relieving cross-border-relevant congestions shall be covered by TSOs responsible for the control areas in proportion to the aggravating impact of energy exchange between given control areas on the congested grid element. 2. In determining whether congestion have cross-border relevance, the TSOs shall take into account the congestion that would appear in the absence of energy exchanges between control areas”*.
180. Article 76(1) SO states that costs of non-CB relevant congestions shall be borne by the TSO responsible for the given control area. ACER Decision 30/2020’s RDCTCS complies with this: cost sharing under the RDCTCS does not apply to non-XNEs. Article 76(1) SO further states that costs of relieving CB-relevant congestions shall be covered by TSOs responsible for the control areas in proportion to the aggravating impact of energy exchange between given control areas on the congested grid element. In other terms, costs of XRAs shall be covered by responsible TSOs in proportion to their contribution to the congestion on the congested XNE. The provision correctly reflects that, according to the PPP, TSOs contributing to the congestion need to be identified in order to make them contribute to the RA costs on XNEs.
181. Article 76(2) SO requires that, in determining whether congestion has CB relevance, TSOs shall take into account the congestion that would appear in the absence of energy exchanges between control areas.
182. First, as expressly set out in paragraph 133 of the Contested Decision, the threshold of ≥ 220 kV was set in accordance with the PPP articulated in Article 76 SO and took account of the structural congestion that would appear in the absence of energy exchanges. This threshold implies that, in the absence of energy exchanges, NEs ≥ 220 kV would not be congested and are thus XNEs.
183. Second, Article 76(2) SO refers to the absence of energy exchanges between control areas. This means that there is no explicit prohibition for other congestions to be taken into account. If the congestion that would appear in the absence of energy exchanges between control areas (i.e. between BZs) would be the only factor to distinguish between cross-border congestions and non-cross-border relevant congestions, then the congestion caused by LFs (due to energy exchanges within BZs) would not be considered as cross-border relevant. This would contradict the PPP of Article 16(13) ER.
184. To conclude, the scope of ACER Decision 30/2020’s RDCTCS has been set in accordance with the CACM, the ER and the PPP, both as articulated in Article 16(13) ER and in 76 SO. If a sub-set would be removed from the RDCTCS scope, compliance with this applicable regulatory framework could not be ensured.

1.1.8 The blending of the scope of RAs deriving from CROSA was decided upon by ACER Decision 07/2019 and not appealed.

185. Matching the scope of RAs following a CROSA process in RDCT and ROSC, and hence in RDCTCS, derives from ACER Decision 07/2019 on CSAM at EU level. ACER Decision 07/2019 which was addressed to All TSOs, including Core TSOs, has not been appealed, neither by Core TSOs nor by Core NRAs.

1.1.9 The RDCTCS infringes the principle of proportionality.

186. Appellant I³⁵ claims that the RDCTCS scope beyond the inclusion of interconnectors infringes the principle of proportionality. It holds that the RDCTCS should be proportionate to the aim of the ER, which is to foster CB exchanges in electricity. It refers to Recital (74) ER. Appellant I holds that interconnector capacities should not be limited by internal network congestions and that this is already sufficiently done in the course of mapping.
187. The principle of proportionality is a general principle of EU law. Article 5(4) TEU provides that “under the principle of proportionality, the content and form of Union action shall not exceed what is necessary to achieve the objectives of the Treaties.” and Recital (45) of the ACER Regulation states: “In accordance with the principle of proportionality, as set out in that Article, this Regulation does not go beyond what is necessary in order to achieve those objectives.”. Also, the CACM expressly highlights in Recital (32) that its rules are proportionate. Recital (74) ER states: “Since the objective of this Regulation, namely the provision of a harmonised framework for cross-border exchanges of electricity, cannot be sufficiently achieved by the Member States but can rather, by reason of its scale and effects, be better achieved at Union level, the Union may adopt measures, in accordance with the principle of subsidiarity, as set out in Article 5 of the Treaty on European Union. In accordance with the principle of proportionality, as set out in that Article, this Regulation does not go beyond what is necessary in order to achieve that objective.”
188. In line with the Board of Appeal’s consistent decision-making practice, ACER is bound by the general principles of EU Law, including the principle of proportionality³⁶.
189. The main objectives of the CACM are:
“(a) promoting effective competition in the generation, trading and supply of electricity; (b) ensuring optimal use of the transmission infrastructure; (c) ensuring operational security; (d) optimising the calculation and allocation of cross-zonal capacity; (e) ensuring fair and non-discriminatory treatment of TSOs, NEMOs, the Agency, regulatory authorities and market participants; (f) ensuring and enhancing the transparency and reliability of information; (g) contributing to the efficient long-term operation and development of the electricity transmission system and electricity sector in the Union; (h) respecting the need for a fair and orderly market and fair and orderly price formation; (i) creating a level playing field for NEMOs; (j) providing non-discriminatory access to cross-zonal capacity.”³⁷.
190. The objectives of the CACM are highlighted in Recital 1(1) CACM:
“The urgent completion of a fully functioning and interconnected internal energy market is crucial to the objectives of maintaining security of energy supply, increasing competitiveness and ensuring that all consumers can purchase energy at affordable prices. A well-functioning internal market in electricity should provide producers with appropriate incentives for investing in new power generation, including in electricity from renewable energy sources, paying special attention to the most isolated Member States and regions in the Union’s energy market. A well-functioning market should also provide consumers with adequate measures to promote more efficient use of energy, which presupposes a secure supply of energy.”
191. Article 1(1) ER states that the ER aims to
“(a) set the basis for an efficient achievement of the objectives of the Energy Union and in particular the climate and energy framework for 2030 by enabling market signals to be delivered for increased efficiency,

³⁵ Appeal I, Plea 1, paras 26-125.

³⁶ Board of Appeal Decisions A-001-2017, paras 69 and 114; A-002-2018, para 59; A-001-2019, paras 43, 56, 233-239; A-003-2019, para 149; A-006-2019, paras 41 and 47; A-001-2020, paras 240, 252 and 263; A-002-2020, paras 241, 253 and 264; A-003-2020, para 206 and 235; A-007-2020, paras 66 and 99 and A-008-2020, paras 292-302.

³⁷ Article 3 of the CACM.

higher share of renewable energy sources, security of supply, flexibility, sustainability, decarbonisation and innovation”;

- (b) set fundamental principles for well-functioning, integrated electricity markets, which allow all resource providers and electricity customers non-discriminatory market access, empower consumers, ensure competitiveness on the global market as well as demand response, energy storage and energy efficiency, and facilitate aggregation of distributed demand and supply, and enable market and sectoral integration and market-based remuneration of electricity generated from renewable sources;*
- (c) set fair rules for cross-border exchanges in electricity, thus enhancing competition within the internal market for electricity, taking into account the particular characteristics of national and regional markets, including the establishment of a compensation mechanism for cross-border flows of electricity, the setting of harmonised principles on cross-border transmission charges and the allocation of available capacities of interconnections between national transmission systems” and*
- “(d) facilitate the emergence of a well-functioning and transparent wholesale market, contributing to a high level of security of electricity supply, and provide for mechanisms to harmonise the rules for cross-border exchanges in electricity”.*

192. ACER Decision 30/2020’s RDCTCS was adopted upon joint request of the NRAs confirming their failure to reach an agreement and is a result of the gradual coordination and integration of the internal electricity market foreseen by the CACM and ER.
193. As set out above in the First Consolidated Plea, defining the scope of the ACER Decision 30/2020’s RDCTCS as including XNEs, in accordance with the ROSC and RDCT at Core level and CSAM at EU level, was not only necessary but also suitable to ensure compliance with the applicable regulatory framework foreseen by both the CACM and the ER. A narrower scope, which would consider only a sub-set of the scope of XNEs of Article 5 ROSC/Article 3 RDCT, regardless of its nature (be it interconnectors, CNECs or any other sub-set), would not only infringe Article 74(2) CACM, but also undermine cost sharing under the RDCTCS, as well as a correct functioning of the ROSC and RDCT and would even negatively affect efficient overall CACM in the Core CCR, in violation of Article 16 ER. The CACM and ER objectives of cost sharing of RA coordination, and of coordination RAs *per se* would not be attained, as set out in Sub-plea 1.1.7 of the First Consolidated Plea.
194. ACER Decision 30/2020’s RDCTCS does not exceed what is necessary to achieve the CACM’s objective and is suitable to achieve that objective. Indeed, ACER Decision 30/2020’s RDCTCS could not have ensured compliance with Articles 74 CACM and 16 ER had it not defined the scope of the RDCTCS in accordance with the scope of Article 5 ROSC/Article 5 RDCT.
195. The EU applicable regulatory framework foresees coordinated methodologies to identify the optimal CM measures, regardless of their cost. A correct scope of the methodologies is therefore key, as it impacts *a priori* the choice of the most optimal CM measure and, hence, the essence of CM.
196. Impeding the inclusion of some NEs in costly RDCT whilst overly extending CC to NEs may affect the optimal CM choice: where CC processes do not prove to be the economically most efficient means to address congestion, TSOs have alternative measures to ensure OS.

1.1.10 The RDCTCS scope allows for exceptions upon common agreement by All Core TSOs.

197. The scope of the RDCTCS, RDCT and ROSC, applying to CNEs and NEs ≥ 220 kV, allows All Core TSOs to unanimously agree to exclude NEs ≥ 220 kV from its scope, as long as they are not CNEs.

1.2 The RDCTCS scope refers to other methodologies.

198. Appellant I opposes the cross-references between methodologies because the purpose of the RDCT and ROSC are different. It makes a special reference to paragraph (58) of ACER

Decision 35/2020: *“The question of cross-border relevance of network elements is addressed in Article 4 of the Proposal. The selection of cross-border relevant network elements (‘XNEs’) was based on the sensitivity threshold. Such provision is not consistent with the ROSC Methodology which specified that all critical network elements used at the capacity calculation, and all other network elements of 220 kV voltage level and above shall be considered as cross-border relevant, except those network elements which Core TSOs agree to exclude”.*

199. Paragraph 58 of ACER Decision 35/2020 correctly describes the fact that ACER, when carrying out its regulatory supervision of All Core TSOs’ RDCT Proposal, assessed that the definition of XNEs had to match the definition of XNEs of All Core TSOs’ ROSC Proposal. The Board of Appeal refers to Sub-Plea 1.1 regarding the reasons why the scope of the RDCTCS, RDCT and ROSC need to match.
200. According to Appellant I, the ROSC - a methodology for regional OS coordination, based on Article 76 SO – is meant to merely complement the RDCT and RDCTCS. Article 76 SO stipulates that the ROSC shall *“complement, where necessary, the methodologies developed in accordance with Articles 35 and 74 of Regulation (EU) 2015/1222.”* Appellant I approves the inclusion of all internal NEs to ensure security of the network in accordance with Article 76 SO. In its view, the inclusion of internal NEs is justified when ensuring system security across BZs (Article 76 SO) but is not justified when providing a mechanism to execute XRAs that enable TSOs to effectively relieve physical congestion (irrespective of whether the reasons for the physical congestion fall mainly outside their control area), in accordance with Article 35 CACM. Distributing RDCT costs across borders does not, in its view, justify the inclusion of internal NEs.
201. The Board of Appeal refers to Sub-plea 1.1 above, which sets out that (i) the differentiation between material processes to ensure OS, governed by SO, on the one hand, and material processes enabling CB trade, governed by CACM, on the other hand, is incorrect; (ii) the applicable regulatory framework, to be found in the CACM and SO, links all 3 Core methodologies, whilst referring at the same time to the EU CSAM; (iii) at EU level, the CSAM requires an identification of NEs where OS violations need to be managed in a coordinated way and (iv) ACER Decision 30/2020 complies with the PPP as articulated in Article 16(13) ER and Article 76 SO.
202. At EU level, the debate as to whether to have two separate processes or one single process has already been held in the bottom-up decision-making process leading up to ACER Decision 07/2019 on the CSAM, when a similar distinction had been tabled by All TSOs to have separate processes for RAs under Article 35 CACM, on the one hand, and for RAs under Article 74 CACM, on the other hand. Paragraphs 65 to 67 of said decision state that ACER did not consider this approach compliant with the SO for 2 main reasons:
- “(65) First, the SO Regulation does not allow to separate remedial actions that need to be managed in a coordinated way into two separate categories with different levels of coordination. In particular, Articles 21(1) and 76(1)(b) of the SO Regulation require that all remedial actions that need to be managed in a coordinated way be used to address operational security violations that need to be managed in a coordinated way and that this coordination ensure the identification of the most effective and economically efficient remedial actions. The Proposal would clearly legitimise two separate coordination procedures which would not be able to identify the most effective and economically efficient remedial actions to address operational security violations that need to be managed in a coordinated way.*
- (66) Second, the Proposal does not clearly specify that the coordination of cross-border impacting remedial actions is performed at regional level and the central coordination role is not given to the RSC as required by Articles 77 and 78 of the SO Regulation.*
- (67) Therefore, the Agency deems that the concept of cross-border relevant redispatching and countertrading actions and cross-border relevant congestions defined within the methodology referred to in Article 35 of the CACM Regulation cannot be separated from the concept of operational security violations and remedial actions that need to be managed in a coordinated way pursuant to Articles 21 and 76 of the SO Regulation, since all remedial actions that need to be managed in a coordinated way (including redispatching and countertrading) are required to be coordinated in one single coordination and optimisation process and not in two separate and*

materially different coordination procedures. With this respect, the requirement in Article 76(1) of the SO Regulation that the methodology pursuant to Article 76(1) of the SO Regulation shall ‘complement where necessary the methodologies developed in accordance with Articles 35 and 74 of the CACM Regulation’ can only be consistently implemented if the methodology pursuant to Article 76(1) of the SO Regulation encompasses the full scope of the methodologies pursuant to Articles 35 and 74 of the CACM Regulation and includes additional elements specifically required by the methodology pursuant to Article 76(1) of the SO Regulation. Any other implementation of the reference to ‘complement where necessary’ would not be compliant with Articles 21 and 76 of the SO Regulation.

(68) For the reasons above, the Agency replaced all references to the cross-border impacting remedial actions with the references to cross-border relevant remedial actions in order to ensure full consistency with the methodologies developed in accordance with Articles 35 and 74 of the CACM Regulation.”

203. A similar debate has taken place during the bottom-up decision-making process leading-up to ACER Decision 35/2020 (RDCT). The Explanatory Document to All Core TSOs’ RDCT Proposal of 5 September 2018, published for consultation³⁸, distinguished between CB relevance in accordance with Article 35(1) CACM and the broader concept of “CB impact” in accordance with Article 76 SO. However, as set out above, All Core TSOs’ RDCT Proposal was modified in order to amend the RDCT scope to CNEs and NEs ≥ 220 kV.

1.3 The RDCTCS scope should match a “significant impact”-test or the scope of DA and ID Core CCM.

204. It is incorrect that Article 16(13) ER lays down a test for the RDCTCS scope in terms of significant impact. Article 16(13) ER relies upon the significant impact test of the definition of structural congestion according to Article 2(4) ER to determine a *de minimis* threshold for polluting flows.

205. ACER Decision 30/2020’s RDCTCS scope duly requires TSOs causing polluting flows to contribute to RA costs in accordance with Article 16(13) ER, which requires an identification of the polluter in accordance with the PPP.

206. The Board of Appeal reiterates the scope of the ACER Decision 30/2020’s RDCTCS, which covers all CNEs of the CCM scope, but is not limited to CNEs:

<p>XNEs =</p> <p>Includes: • all CNEs (CCM) (according to a yearly list of CNEs):</p> <ul style="list-style-type: none"> - all CZ NEs - all internal NEs, defined by All Core TSOs, with a BZ-to-BZ PTFDF $\geq 5\%$ <p>• other NEs ≥ 220 kV</p> <p>Excludes: XNEs that are not CNEs, i.e.:</p> <ul style="list-style-type: none"> - radial lines, distribution NEs, transformers with secondary voltage < 220 kV - other NEs as commonly agreed upon by All Core TSOs - XNEs that are part of another CCR CROSA (for TSOs belonging to more than one CCR)

Source: Board of Appeal.

207. The Board of Appeal refers to Sub-plea 1.1, in which it sets out in detail the reasons why the scope of the RDCTCS needs to cover XNEs.

208. CCM and RDCTCS are two different short-term measures under CACM, which explains why they have a different scope.

209. CC processes consider RAs but do not apply RAs and, hence, do not create costs. They are aimed at maximising CB trade, whilst respecting OS and avoiding undue discrimination between internal and CB exchanges. DA and ID Core CCM are tools to maximise CB trade in case of congestion on the grid until enduring mid-term and long-term solutions are reached, whilst respecting OS. They are a short-term “safety net” and involve an efficiency assessment

³⁸ <https://eepublicdownloads.entsoe.eu/clean-documents/Network%20codes%20documents/Implementation/ccr/methodologies/core/cacm-deliverables/coordinated-rd-and-ct-art-35/201902-core-cacm-35-methodology.pdf>.

(including a cost assessment) of other short-term, mid-term and long-term solutions, e.g. RDCTs and their costs.

210. RDCT coordination processes apply RAs and therefore create costs that need to be shared.

211. As set out above in Sub-plea 1.1.2, impeding the inclusion of some XNEs in costly RAs whilst overly extending CC to XNEs may affect the optimal CM choice (a choice could be made for CC even it would not prove to be the economically most efficient means to address congestion). RAs are CM measures of last resort, close to real time. Hence, a restrictive approach on the XNEs to include in its scope would imply that there would remain no alternative solution to solve congestions on the excluded XNEs, threatening OS. Moreover, the exclusion of XNEs from RAO would not only maintain but even worsen OS issues in relation to these XNEs. Given that these XNEs have cross-border relevance, they are impacted by RAs activated to solve violations on included XNEs. Wrongfully excluding such XNEs from the scope would not be able to eliminate their intrinsic cross-border nature. Indeed, cross-border relevance of XNEs involves the mutual interdependency of such XNEs and RAs by laws of physics. Such excluded XNEs would, therefore, be impacted by RA activation on included XNEs, with likely negative OS consequences.

212. Under the CROSA process, the optimised and coordinated RDCT actions aim to relieve physical congestion on all XNEs (i.e. CNEs and NEs ≥ 220 kV), irrespective of whether the reasons for the physical congestion fall inside or outside the TSOs' control area.

213. The erroneous exclusion of XNEs from the CROSA scope has as a consequence that physical congestion will not be relieved on the excluded XNE and threatens OS on that XNE. Conversely, the erroneous inclusion of XNEs in the CROSA scope does not threaten OS because cross-border relevance depends on the laws of physics and the interdependency between XNE and RAs, which will simply not occur.

214. Appellant I correctly states that one should distinguish between the CCM and the RDCTCS processes³⁹, given that the CCM process does not include the sharing of costs, whereas the RDCTCS amounts to cost sharing. That is precisely why ACER Decision 30/2020's RDCTCS scope goes beyond the scope of the CCM.

1.4 The RDCTCS scope infringes Article 74(2) CACM and is inconsistent per se.

215. Appellant I claims that ACER Decision 30/2020's RDCTCS scope infringes Article 74(2) CACM, because it only allows for cost sharing on interconnectors or CNEs.

216. Article 74(2) CACM requires the RDCTCS to *"include cost-sharing solutions for actions of cross-border relevance."*

217. As set out in detail above in Sub-plea 1.1., Article 74(2) CACM requires the RDCTCS to include XRAs on XNEs. The test of "CB relevance" does not limit cost sharing to interconnectors, CNEs or congestions between BZs. ACER Decision 30/2020's RDCTCS does not infringe Article 74(2) CACM but correctly complies with Article 74(2) CACM.

218. Appellant I draws a clear difference between the cost-sharing process prior to mapping and the cost-sharing process after mapping. It alleges that, prior to mapping, the scope of ACER Decision 30/2020's RDCTCS is lawful, but that after mapping, the scope of ACER Decision 30/2020's RDCTCS is unlawful. Appellant I claims that, after mapping, the cost distribution should not include the broad scope of ACER Decision 30/2020's RDCTCS but should be limited to interconnectors. Consequently, cost distribution on the basis of the PPP should only be applied to interconnectors. In Appellant I's view, this interpretation is confirmed by the definition of relevance (i.e. the degree to which something is related or useful to what is happening or being talked about, as per the Cambridge Dictionary), which implies that the

³⁹ Appeal I, Plea 1, para 117.

concept of CB relevance is inherently limitative and cannot imply the inclusion of internal NEs after mapping, especially when they are sufficiently included in the course of mapping.

219. The Board of Appeal refers to Sub-Plea 1.1. Article 74(2) CACM requires the RDCTCS to include XRAs on XNEs. The test of CB relevance does not exclude internal NEs, neither during mapping nor during the remaining steps of the RDCTCS pursuant to mapping.
220. The mapping process of ACER Decision 30/2020's RDCTCS assigns the costs and revenues of each identified RA to a XNE that falls within the scope of the RDCTCS, on an hourly basis. Mapping is a first step of Title 3 of ACER Decision 30/2020's RDCTCS. Mapping of XRA costs to XNECs corresponds with Article 5 of ACER Decision 30/2020's RDCTCS. After mapping, Title 3 of ACER Decision 30/2020's RDCTCS contains additional steps, namely flow decomposition on XNECs (Article 6) and distribution of costs on XNECs to TSOs (Article 7).
221. The Board of Appeal finds that, if the scope of the RDCTCS is narrowed down and excludes a sub-set of XNECs from the flow decomposition on XNECs and distribution of costs on XNECs (beyond the exceptions provided by ACER Decision 30/2020's RDCTCS), this removal of a sub-set of XNECs after mapping infringes the CACM and the ER for exactly the same reasons that are provided in this First Consolidated Plea, in particular Sub-Plea 1.1.7. A differentiation between mapping and post-mapping steps within cost sharing does not alter the conclusions as to the lack of compliance with Article 74 CACM (e.g. as regards incorrect incentives, TSOs' responsibilities and liabilities or the infringement of the principle of non-discrimination) and 16 ER (e.g. as regards the infringement of the principle of non-discrimination and a failure to apply the PPP).

1.5 The RDCTCS scope wrongly includes internal NEs.

222. Appellant I differentiates between internal NEs and internal CNEs as per CCM. Appellant I claims that the RDCTCS scope wrongly includes internal NEs that are not CB NEs (interconnectors) after mapping.
223. As set out above in Sub-Pleas 1.1 and 1.3, the RDCTCS scope including internal NEs is necessary to ensure compliance with the applicable regulatory framework set by CACM and ER. A removal of internal NEs from the scope would infringe both Article 74(2) of the CACM, which requires the RDCTCS to apply to XNEs, and Articles 16 ER, 74 and 3 CACM, which require the RDCTCS not to discriminate, to apply the PPP to polluting flows after having set a *de minimis* threshold. Article 16(13) ER clearly states that the application of the PPP requires an analysis to what extent flows resulting from transactions internal to BZs contribute to the congestion. Flows resulting from transactions internal to BZs are IFs or LFs and need to be identified in the decomposition of flows on XNECs (Article 6 of ACER Decision 30/2020's RDCTCS).
224. The Board of Appeal observes that one should carefully differentiate between the scope, on the one hand, and the distribution of costs, on the other hand.
225. Regarding the scope, all XNEs should be included, also internal XNEs (which host and cause a variety of flows, not only IFs). By removing internal XNEs from the scope of the RDCTCS, TSOs causing LFs that congest those internal XNEs would not be accountable under the PPP and a situation of free-riding would be created.
226. Regarding the distribution of costs, the RDCTCS (i) sets a *de minimis* threshold for LFs above which they contribute to the costs, whereas it does not set any threshold for IFs; (ii) prioritizes LFs above the threshold, which come first in the flow stack, over IFs, which come second in the flow stack; and (iii) applies the PPP to LFs above the threshold and applies the OPP to IFs. The Board of Appeal notes that, given the fact that IFs are created by the owners of

internal NEs, applying the OPP or the PPP to IFs would place the cost burden on the same TSO.

227. The claim that internal NEs are different from other NEs and that, hence, treating them differently would not be discriminatory, is erroneous. Cost sharing derives from RAs to relieve congestion on NEs. RAs to relieve congestion on internal NEs are not different from RAs to relieve congestion on other NEs. Hence, there is no different situation justifying a different treatment under the principle of non-discrimination. Internal NEs may be different in many perspectives from other NEs, but there is no difference when it comes to RAs and hence, introducing a difference when it comes to sharing the costs of RAs would be discriminatory.
228. Appellant I also claims that, even if the RDCTCS scope were to correctly exclude internal NEs after mapping, the RDCTCS scope wrongly includes internal CNEs that are not CB NEs (interconnectors). According to paragraph 47 of Appellant I's Appeal, including all internal CNEs after mapping (even though all internal NEs were correctly excluded) "*would lead to an even worse situation for the German TSOs and network users*". This, in its opinion, is because (i) the internal CNEs are, by definition, specifically burdened with too many IFs, rendering them "critical" NEs, and (ii) only a few LFs from other BZs could lead to overload situations which need to be resolved by RAs. Appellant I refers to Article 2(69) ER, which defines CNEs as "*network elements either within a bidding zone or between bidding zones taken into account in the capacity calculation process, limiting the amount of power that can be exchanged*". Therefore, CNEs are, in its opinion, limited to NEs limiting CB trade, as used in DA and ID Core CCM. Appellant I claims that the inclusion of internal NEs/CNEs is sufficiently done in the course of mapping to ensure that RAs contributed by internal NEs are not borne by CB NEs. In its view, internal NEs/CNEs should not be done after mapping, i.e. it should not be expanded to flow decomposition and flow stacking.
229. The Board of Appeal refers to Sub-plea 1.1 above, which sets out that the exclusion of internal NEs would infringe Article 74 CACM as well as Article 16 ER. This statement is valid in relation to an alleged exclusion of internal NEs or internal CNEs. As set out above, the Board of Appeal observes that the scope of the RDCTCS should be identical during and after mapping.
230. The Board of Appeal refers to Sub-plea 1.3 above, which sets out that CNEs used in DA and ID Core CCM are part of the RDCTCS scope but that limiting the RDCTCS to CNEs would infringe both Article 74 CACM and 16 ER.

1.6 The RDCTCS scope infringes Article 16(8), 16(4) and 16(13) ER.

231. According to Appellant I, Articles 16(8) and (13) ER are *lex superior (lex generalis)* and *lex posterior* and limit the scope of the RDCTCS to congestions on interconnections between BZs. The RDCTCS taken on the basis of Article 74 CACM needs to comply with said Article 16(8) and (13) ER, as expressly provided for by Article 74(6)(b),(d) and (f) CACM.
232. Appellant I alleges that Article 16(8) ER prohibits TSOs from restricting interconnection capacities to relieve internal network congestions in their own BZ and are financially penalised in case of non-compliance (Article 16(12) ER).
233. Article 74(6)(b) CACM requires the RDCTCS to "*be consistent with the responsibilities and liabilities of the TSOs involved (..)*".
234. Article 74(6)(d) CACM requires the RDCTCS to "*be consistent with other related mechanisms, including at least: (i) the methodology for sharing congestion income set out in Article 73; (ii) the inter-TSO compensation mechanism, as set out in Article 13 of Regulation (EC) No 714/2009 and Commission Regulation (EU) No 838/2010 (1)*". (emphasis added)

235. Article 74(6)(f) CACM requires the RDCTCS to “*facilitate adherence to the general principles of congestion management as set out in Article 16 of Regulation (EC) No 714/2009.*”
236. Article 16(8) ER states as follows: “*Transmission system operators shall not limit the volume of interconnection capacity to be made available to market participants as a means of solving congestion inside their own bidding zone or as a means of managing flows resulting from transactions internal to bidding zones. Without prejudice to the application of the derogations under paragraphs 3 and 9 of this Article and to the application of Article 15(2), this paragraph shall be considered to be complied with where the following minimum levels of available capacity for cross-zonal trade are reached: (a) for borders using a coordinated net transmission capacity approach, the minimum capacity shall be 70 % of the transmission capacity respecting operational security limits after deduction of contingencies, as determined in accordance with the capacity allocation and congestion management guideline adopted on the basis of Article 18(5) of Regulation (EC) No 714/2009; (b) for borders using a flow-based approach, the minimum capacity shall be a margin set in the capacity calculation process as available for flows induced by cross-zonal exchange. The margin shall be 70 % of the capacity respecting operational security limits of internal and cross-zonal critical network elements, taking into account contingencies, as determined in accordance with the capacity allocation and congestion management guideline adopted on the basis of Article 18(5) of Regulation (EC) No 714/2009. The total amount of 30 % can be used for the reliability margins, loop flows and internal flows on each critical network element.*”
237. Article 16(12) ER states: “*The financial consequences of a failure to honour obligations associated with the allocation of capacity shall be attributed to the transmission system operators or NEMOs who are responsible for such a failure. Where market participants fail to use the capacity that they have committed to use, or, in the case of explicitly auctioned capacity, fail to trade capacity on a secondary basis or give the capacity back in due time, those market participants shall lose the rights to such capacity and shall pay a cost-reflective charge. Any cost-reflective charges for the failure to use capacity shall be justified and proportionate. If a transmission system operator does not fulfil its obligation of providing firm transmission capacity, it shall be liable to compensate the market participant for the loss of capacity rights. Consequential losses shall not be taken into account for that purpose. The key concepts and methods for the determination of liabilities that accrue upon failure to honour obligations shall be set out in advance in respect of the financial consequences, and shall be subject to review by the relevant regulatory authority.*”
238. First, the creation of the RDCTCS is mandated by Article 74 CACM, which is an implementing act of the ER and expressly sets out in Article 74(6)(f) that it should “*facilitate adherence to the general principles of congestion management as set out in Article 16 of Regulation (EC) No. 714/2009*” (emphasis added). The RDCTCS relates to RDCTs, which are CM measures, whereas Article 16 ER contains the “*general principles of capacity allocation and congestion management*”, i.e. it covers a wider scope of CACM, i.e. CM and CA. Regardless of the fact that the general principles of Article 16 ER have been adopted after the CACM, ACER Decision 30/2020’s RDCTCS needs to comply with the ER to the extent that they are CM principles, because RDCT are CM measures and not CA measures. Yet the general principles of Article 16 ER contain both CA and CM measures.
239. Second, the Board of Appeal refers to Sub-plea 1.1 above, which sets out that ACER Decision 30/2020’s RDCTCS complies with the general principles of CM contained in Article 16 ER, especially Articles 16(1) and (13) ER. In other terms, ACER Decision 30/2020 complies with both the CACM and the higher-ranking ER.
240. Third, even though Article 16(8) and (12) ER contain general principles of CA (maximising interconnection capacity or CZC up to 70% and penalties in case of non-compliance), the correct definition of XNEs in ACER Decision 30/2020’s RDCTCS does not impede reaching the expected level of 70% of CZC on a NE without structural congestion. The fact that interconnection capacity or CZC should be maximised to 70% does not imply that the scope of the RDCTCS should be limited to interconnectors.
241. Appellant I claims that Article 16(13) ER contains a cost sharing solution for congestion between 2 BZs and not for congestion within a BZ (that is why the acceptable LF threshold needs to be set for each individual BZB). In its view, internal NEs cannot be considered as NEs between 2 BZs.

242. As set out above in Sub-Plea 1.1.7, ACER Decision 30/2020's RDCTCS is in line with Article 16(13) ER.
243. In Appellant I's view, ACER Decision 30/2020 does not correctly apply the PPP but effectively creates a system of free-riding cross-subsidization. In its view, costs on internal NEs/CNEs should be borne by the TSOs operating the congested internal NEs/CNEs. Instead, the RDCTCS puts the cost burden deriving from internal NEs on TSOs from whose network LFs originate, who are obliged to pay for internal congestions in networks operated by other TSOs. Appellant I adds that a LF's direction may be influenced by the constitution and load situation in a specific network system in another BZ, but that the flows are not caused by TSOs but by the trading activities within a BZ. That reinforces, in its opinion, the fact that TSOs operating the congested NEs have to pay for the needed RAs. In its Reply, Appellant I alleges that the concept of cross-border relevance does not mean being significantly affected by LFs⁴⁰.
244. The Board of Appeal refers to Sub-plea 1.1.7, which set out that ACER Decision 30/2020's RDCTCS correctly applies the PPP with respect to internal NEs.
245. The costs to be shared under the RDCTCS are costs that stem from RAs to relieve congestion on NEs. Therefore, when sharing costs in accordance with the PPP, the burdening factor is the contribution to the congestion through electricity flows. This is expressly set out by Article 16(13) ER, which requires that the physical flows resulting from electricity exchanges or transactions internal to BZs - i.e. IFs and LFs - should be identified as contributors to the congestion. It further requires that, when allocating costs, the ensuing cost sharing methodology allocates them to TSOs of the BZs causing such flow, based on the contribution to the congestion to TSOs of BZs.
246. In case of CZ NEs, these flows are LFs, whereas in case of internal NEs, these flows are IFs and LFs (IFs caused by electricity exchanges within the BZ where the NE is located and LFs caused by electricity exchanges within other BZs). Since TSOs causing IFs are financing the investment and maintenance of such internal NEs via network fees or tariffs, whereas TSOs causing LFs are not, the LFs beyond a legitimate level (i.e. the level that could be expected without structural congestion in a BZ) should be identified as the primary contributor to the congestion on internal NEs, whereas IFs should be penalised only for the remaining volume of congestion.
247. Appellant I erroneously reverses the PPP and applies it to the polluting flow hosting TSOs, which Article 16(13) ER does not identify as polluters that should contribute to the RDCTCS. In the absence of IFs or LFs from polluting flow causing TSOs, the internal NEs of the polluting flow hosting TSOs would not be congested. Article 16(13) ER does not define pollution as a lack of maintenance or investment. Pollution is clearly defined as the contribution to the congestion through electricity flows.

1.7 The RDCTCS scope infringes Article 74(6)(a) CACM.

248. Article 74(6)(a) CACM states that the RDCTCS shall provide incentives to invest effectively.
249. Appellant I claims that the allocation of costs to other BZs does not incentivize TSOs of the congested NE to invest into the required network expansion. In its view, charging German network users to pay for resolving internal congestions within non-German networks does not incentivise non-German TSOs to resolve their internal congestions at the expense of its own network users. This is unreasonable because German TSOs and network users have no tools to remedy non-German internal congestions.

⁴⁰ Reply of Appellant I, para 28.

250. Appellant I differentiates between internal NEs and internal CNEs but alleges that the inclusion of both creates wrong incentives for investments. As regards internal CNEs, Appellant I alleges that their inclusion enhances the share of the costs to be borne by TSOs in whose BZ more LFs are created.
251. Article 74(6)(a) CACM, which requires the RDCTCS to *“provide incentives to manage congestion, including remedial actions and incentives to invest effectively”*.
252. As set out above, a distinction needs to be made between the scope of the RDCTCS and the cost distribution of the RDCTCS.
253. As set out above, internal XNEs need to be included in the scope of the RDCTCS. Removing internal XNEs from the scope of the RDCTCS would imply that, on the one hand, LF-causing TSOs would not have to pay the costs although they did not sufficiently invest in their electricity network or did not change their BZ configuration in order to reduce LFs that pollute internal XNEs owned by LF-hosting TSOs whereas, on the other hand, LF-hosting TSOs would have to bear these costs. Moreover, if the RDCTCS were not to apply to internal XNEs, this would lead to the unfair situation that TSOs facing congestion on a BZB due to LFs would be entitled to cost sharing whereas TSOs facing congestion on other XNEs (not on a BZB) would not be entitled to cost sharing. Not applying the RDCTCS to internal XNEs would not provide the correct incentives to LF-causing TSOs to take the necessary measure to reduce their LFs below the legitimate LF threshold, e.g. through investments in network upgrades. Furthermore, as set out by ACER in its Defence, solving LFs on LF-causing XNEs is a prerequisite for LF-causing TSOs in order to solve problems of IFs causing internal congestion.
254. Regarding cost attribution of IFs, ACER Decision 30/2020’s RDCTCS applies the OPP when attributing costs of IFs on a XNEC to TSOs. IFs are borne by the XNE connecting TSOs.
255. Claiming that the requirement that the polluting flow hosting TSOs should contribute to the costs amounts to a reversal of the PPP. Article 16(13) ER does not identify polluting flow hosting TSOs as polluters that should contribute to the RDCTCS. Article 16(13) ER does not define pollution as a lack of maintenance or investment. Pollution is clearly defined as the contribution to the congestion through electricity flows.
256. With respect to paragraph 71 of ACER Decision 30/2020, it reads as follows: *“Excluding some cross-border relevant network elements from cost sharing would also contradict the general principles of congestion management in accordance with Article 16(1) of the Electricity Regulation by which network congestion problems should be addressed with non-discriminatory market-based solutions which give efficient economic signals to the market participants and transmission system operators involved. This general principle was applied in ACER Decision 02/2019 of 21 February 2019 on the Core CCR TSOs’ proposals for the regional design of the day-ahead and intraday common capacity calculation methodologies. Articles 5 of Annexes I and II of this Decision set out the requirements for Core TSOs to continuously monitor and identify the most efficient congestion management method for congestions on internal network elements, among which are capacity calculation, remedial actions, reconfiguration of bidding zones and network investments. The solution by which congestion problems can be addressed with remedial actions crucially depends on the coordination of remedial actions and related cost-sharing. Thus, in the absence of cost-sharing for specific congested network elements, remedial actions could no longer be considered as an alternative congestion management method for these elements. As a consequence, this would prevent efficient congestion management as required by Article 16(1) of the Electricity Regulation.”*
257. Regarding the statement in paragraph 71 that there are alternative means for other TSOs to alleviate congestions on internal XNEs caused by IFs, e.g. CC, RAs or reconfiguration of their own BZs and that ACER Decision 30/2020’s RDCTCS is inconsistent with the CCM, the Board of Appeal refers to Sub-Pleas 1.1.2, describing RAs in a zonal market model, and 1.1.7, which sets out that the exclusion of internal XNEs from the scope of the RDCTCS would not only undermine cost sharing under the RDCTCS, but also undermine a correct functioning of the ROSC and RDCT and even negatively affect efficient overall CACM in the

Core CCR. This is because, according to the CCM (ACER Decision 02/2019), Core TSOs are under an obligation to continuously monitor and identify the most efficient CM method for congestions on internal NEs, e.g. CC, RAs, BZ reconfiguration or network investments and their decision to address congestions with RAs depends on the coordination of RAs and related cost-sharing. In the absence of cost sharing for specific congested NEs, RAs could no longer be considered as an alternative CM method for those NEs. This would automatically prevent efficient CM as required by Article 16(1) ER. CCM and CROSA need to be fully integrated as both are measure foreseen by CACM. Through the identification of the most effective CM measures, CACM aims at maximising CZC and ensuring OS.

258. Appellant I adds that, apart from the wrong incentives to TSOs, the RDCTCS sets incentives that contradict the European goal of completing the internal electricity market by fostering CB trade and market integration of renewable energies, in particular the climate neutrality goal for 2050. TSOs of BZs with more renewable energy, and their consumers, need to contribute to resolve internal congestions on networks of TSOs that do not use renewable energy.
259. The objective of the RDCTCS is not to penalise TSOs from BZs with renewable energy.
260. First, climate change measures require investments that can only adequately be carried out in a Core region that is coordinated in terms of RAs. An adequate level of coordination in terms of RDCTs and OS can only be achieved through a corollary cost sharing system, as provided for in the RDCTCS. As set out above, the RDCTCS plays a role in the identification of the most effective CM measures under CACM aims to maximise CZC and ensure OS. In so doing, ACER Decision 30/2020's RDCTCS has been designed in way that ensures an adequate level of investments in the long term and provides correct economic signals in accordance with 74 CACM and 16 ER, whilst fostering integration of Core CCR in terms of congestions. This adequate level of investments will foster, in the long term, correct investment initiatives by All Core TSOs and a smooth transition of the entire Core CCR towards decarbonisation.
261. Second, as more renewable energy is connected, OS challenges will increase across the EU. RES are prone to causing LFs. Given the time lags associated with new transmission investment and BZ reconfiguration, short periods of high RDCT costs are possible. This means that it is particularly important to ensure co-ordination in the execution of RAs in order that overall costs to network users in the EU are minimised.
262. In this regard, the Board of Appeal refers to Recital 23 ER, which states: *While decarbonisation of the electricity sector, with energy from renewable sources becoming a major part of the market, is one of the goals of the Energy Union, it is crucial that the market removes existing barriers to cross-border trade and encourages investments into supporting infrastructure, for example, more flexible generation, interconnection, demand response and energy storage. To support this shift to variable and distributed generation, and to ensure that energy market principles are the basis for the Union's electricity markets of the future, a renewed focus on short-term markets and scarcity pricing is essential.*"

1.8 The RDCTCS scope infringes Article 74(6)(b) CACM.

263. Appellant I stresses that the inclusion of costs for RAs on all internal NEs after mapping and allocation of costs to other BZs disregards the internal responsibility of the TSO of the congested NE.
264. Article 74(6)(b) CACM states that the RDCTCS shall be consistent with the responsibilities and liabilities of the TSOs involved.
265. Costs on XNEs are duly attributed to All Core TSOs in accordance with the PPP as regards LFs above the threshold and in accordance with the OPP as regards IFs (taking account of the

fact that applying the OPP or the PPP to IFs will be similar in terms of cost attribution given the nature of IFs) and other flows.

266. The scope of the ACER Decision 30/2020's RDCTCS does not impede Core TSOs to bear their responsibilities and liabilities. As set out above in Sub-plea 1.1.7, the removal of a subset of XNEs from the scope of the RDCTCS would be contrary to Article 74(6)(b) CACM because All Core TSOs would be infringing their obligations under Article 74 CACM and 16 ER when failing to apply a cost sharing solution to all XNEs. Not sharing costs under the RDCTCS would leave all costs with the TSOs that own congested XNEs.

1.9 The RDCTCS scope infringes Recital (12) CACM and 16(4) ER.

267. Appellant I alleges that the CACM and ER differentiate between XRAs and other RAs, e.g. internal RAs or other non-XRAs. In its opinion, Recital (12) CACM and Article 16(4) ER expressly make this differentiation. It claims that Article 16(4) ER differentiates between, on the one hand, "counter-trading and redispatch", and, on the other hand, "CB redispatch".

268. Recital (12) CACM states: "*TSOs should implement coordinated redispatching of cross-border relevance or countertrading at regional level or above regional level. Redispatching of cross-border relevance or countertrading should be coordinated with redispatching or countertrading internal to the control area.*"

269. Article 16(4) ER states: "*The maximum level of capacity of the interconnections and the transmission networks affected by cross-border capacity shall be made available to market participants complying with the safety standards of secure network operation. Counter-trading and redispatch, including cross-border redispatch, shall be used to maximise available capacities to reach the minimum capacity provided for in paragraph 8. A coordinated and non-discriminatory process for cross-border remedial actions shall be applied to enable such maximisation, following the implementation of a redispatching and counter-trading cost-sharing methodology.*"

270. Article 16(4) ER does not restrict the RDCTCS scope to RDCTs used to maximise capacity but indicates that such RDCTs will be subject to the RDCTCS.

271. CNEs used in DA and ID Core CCM are part of the RDCTCS scope but limiting the RDCTCS to CNEs would infringe both Article 74 CACM and 16 ER.

272. Article 16(4) ER contains the general principle of CACM according to which (i) RDCTs shall be used to maximise capacity as provided by Article 16(8) ER (minimum 70% of CZ trade), following a CROSA and (ii) the RDCTCS will apply to such RDCTs. Again, Article 16(4) ER does not restrict the RDCTCS scope to RDCTs used to maximise capacity but indicates that such RDCTs will be subject to the RDCTCS. This is in line with ACER Decision 30/2020's RDCTCS, which includes CNEs (as per CCM) but is not limited to CNEs and also covers NEs ≥ 220 kV.

273. Furthermore, the text of Article 16(4) ER merely states that RDCTs shall be used to maximise capacity following a CROSA and that these RDCTs shall include CB RDs. It does not by any means imply any exclusion of internal RAs from XRAs.

274. Recital (12) CACM does not imply any exclusion of internal RAs from the RDCTCS scope. It refers to the fact that the introduction of regional coordination of RAs should take account of on-going national coordination of RAs.

1.10 The RDCTCS scope infringes Article 35 CACM and 2(4) ER.

275. Appellant I alleges that Article 35(2) CACM states that XRAs shall only be established in order to resolve CB relevant congestions. Appellant I also refers to Article 2(4) ER and Recital (64) of ACER Decision 35/2020 (RDCT). Hence, in Appellant I's opinion, only RAs exercised to relieve capacity problems between BZs, i.e. interconnectors, should be included in the RDCTCS scope.

276. Article 35(2) CACM states: "*The methodology for coordinated redispatching and countertrading shall include actions of cross-border relevance and shall enable all TSOs in each capacity calculation region to*

effectively relieve physical congestion irrespective of whether the reasons for the physical congestion fall mainly outside their control area or not. The methodology for coordinated redispatching and countertrading shall address the fact that its application may significantly influence flows outside the TSO's control area."

277. Article 2(4) ER defines congestion as “a situation in which all requests from market participants to trade **between network areas** cannot be accommodated because they would significantly affect the physical flows on network elements which cannot accommodate those flows” (emphasis by Appellant I).
278. Recital (64) RDCT reads as follows: “The coordination requirements of Article 35 of the CACM Regulation can be summarised into the requirement for coordination of redispatching and countertrading actions of cross-border relevance **in order to address physical congestions which are also cross-border relevant**. In doing so, TSOs should ensure economic efficiency and effectiveness of these actions.” (emphasis by Appellant I).
279. As set out above in Sub-plea 1.1.7, a limitation of the scope of the RDCTCS to interconnectors would not only infringe Article 74(2) CACM, but also undermine cost sharing under the RDCTCS, undermine a correct functioning of the ROSC and RDCT and even negatively affect efficient overall CACM in the Core CCR.
280. The Board of Appeal refers to Sub-plea 1.1 for the correct definition of CB relevance, which corresponds with CB relevance referred to in Recital (64) and Article 35(2) RDCT. The test laid down for the RDCTCS scope is CB relevance and not congestion.

1.11 The RDCTCS contradicts the creation of the internal energy market.

281. Appellant I claims that the RDCTCS scope contradicts the objective of the CACM and ER to create the internal energy market, which is essentially done through fostering CB trade. Hence, the crucial role of making available CB capacities, also by using RAs. In its view, including RA costs exercised on all internal NEs after mapping leads to an excessive cost sharing of RAs without the necessary CB relevance, whereas the objective of an internal electricity market implies that TSOs pay for congestions on their own NEs no matter where the flow contributing to the congestion stems from. In its opinion, the only acceptable exception is the congestion of interconnectors because as long as BZ limits exist, interconnectors need to be treated differently.
282. Appellant I quotes Recitals (20) and (21) ER:
- “(20) When regional coordination centres carry out a capacity calculation, they should maximise capacity considering non-costly remedial actions and respecting the operational security limits of transmission system operators in the Capacity Calculation Region. Where the calculation does not result in capacity equal to or above the minimum capacities set out in this Regulation, regional coordination centres should consider all available costly remedial actions to further increase capacity up to the minimum capacities, including redispatching potential within and between the capacity calculation regions, while respecting the operational security limits of transmission system operators of the Capacity Calculation Regions. Transmission system operators should report accurately and transparently on all aspects of capacity calculation in accordance with this Regulation and should ensure that all information sent to regional coordination centres is accurate and fit for purpose.”*
- (21) When performing capacity calculation, regional coordination centres should calculate cross-zonal capacities using data from transmission system operators which respects the operational security limits of the transmission system operators' respective control areas. Transmission system operators should be able to deviate from coordinated capacity calculation where its implementation would result in a violation of the operational security limits of network elements in their control area. Those deviations should be carefully monitored and transparently reported to prevent abuse and ensure that the volume of interconnection capacity to be made available to market participants is not limited in order to solve congestion inside a bidding zone. Where an action plan is in place, the action plan should take account of deviations and address their cause.”*
283. As set out above in Sub-plea 1.1.7, a limitation of the scope of the RDCTCS to interconnectors would not only infringe Article 74(2) CACM, but also undermine cost sharing under the RDCTCS, undermine a correct functioning of the ROSC and RDCT and even negatively affect efficient overall CACM in the Core CCR.

284. The Board of Appeal refers to Sub-pleas 1.3 and 1.6 in relation to the difference between the scope of the CC processes, which is included in the RDCTCS scope, on the one hand, and the scope of the RDCTCS, which is broader and encompasses XNEs, on the other hand.
285. Appellant I's claim that the requirement that the polluting flow hosting TSOs should contribute to the costs amounts to a reversal of the PPP. Article 16(13) ER does not identify polluting flow hosting TSOs as polluters that should contribute to the RDCTCS. Article 16(13) ER does not define pollution as a lack of maintenance or investment. Pollution is clearly defined as the contribution to the congestion through electricity flows.
286. The Board of Appeal finds that the scope of ACER Decision 30/2020's RDCTCS does not go counter the EU internal electricity market, but that narrowing the RDCTCS scope to interconnectors would infringe Article 74(6)(e) CACM, which requires the RDCTCS to “(e) facilitate the efficient long-term development and operation of the pan-European interconnected system and the efficient operation of the pan-European electricity market”. As set out above, it would not only obliterate cost sharing under the RDCTCS, but also undermine a correct functioning of the ROSC and RDCT and negatively affect efficient overall CACM in the Core CCR.

1.12 The RDCTCS infringes the principle of non-discrimination.

287. Appellant I⁴¹ differentiates between an illegal inclusion of internal NEs and internal CNEs in the RDCTCS scope and alleges that the RDCTCS discriminates, in both scenarios, against larger BZs, which naturally cause more LFs than smaller BZ. It explains that larger BZs such as Germany have a higher volume of LFs due to a high amount of renewable energies. In its view, the RDCTCS scope discriminates against BZs with a high share of renewable energy production (promoting the European climate targets) because it increases the already high financial burden put on end-consumers stemming from the fact that renewable energy requires high network expansion costs. Appellant I claims that those costs amount to a “two- to three-digit million EUR amount per year in Germany”.
288. The Intervener supports this stance. In its view, on the contrary, the exclusion of a subset of XNEs from the RDCTCS although these XNEs are included in the ROSC (optimisation through CROSA) would lead to an unjustified discrimination⁴². Disregarding LFs on some NEs would be similar to determining an infinite legitimate LF threshold on those XNEs, applying a full OPP to these NEs and carrying out a hidden transfer of costs from TSOs in BZs generating LFs towards TSOs in BZs hosting LF, owning the excluded XNEs.
289. In line with the Board of Appeal's consistent decision-making practice, ACER is bound by the general principles of EU Law, including the principle of non-discrimination⁴³.
290. The principle of non-discrimination is laid down in Article 18 TFEU: “Within the scope of application of the Treaties, and without prejudice to any special provisions contained therein, any discrimination on grounds of nationality shall be prohibited.”
291. It is also set out in Articles 20 and 21 of the Charter:
*“Article 20 Equality before the law. Everyone is equal before the law.
 Article 21 Non-discrimination 1. Any discrimination based on any ground such as sex, race, colour, ethnic or social origin, genetic features, language, religion or belief, political or any other opinion, membership of a national minority, property, birth, disability, age or sexual orientation shall be prohibited. 2. Within the scope of application of the Treaty establishing the European Community and of the Treaty on European Union, and without prejudice to the special provisions of those Treaties, any discrimination on grounds of nationality shall be prohibited.”*

⁴¹ Appeal I, Plea 1, paras 25-125.

⁴² Application for Intervention by the Intervener.

⁴³ Board of Appeal Decisions A-001-2017, paras 69 and 114; A-002-2018, para 59; A-001-2019, paras 43, 56, 233-239; A-003-2019, para 149; A-006-2019, paras 41 and 47; A-001-2020, paras 240, 252 and 263; A-002-2020, paras 241, 253 and 264; A-003-2020, para 206 and 235; A-007-2020, paras 66 and 99 and A-008-2020, paras 292-302.

292. The principle of non-discrimination is also contained in the recitals of the ER and CACM.
293. Article 74(6)(i) CACM requires the RDCTCS to “*comply with the principles of transparency and non-discrimination*”.
294. Article 3(e) CACM cites, as an objective of the CACM, “*ensuring fair and non-discriminatory treatment of TSOs, NEMOs, the Agency, regulatory authorities and market participants*”.
295. Article 16(1) ER states that “*network congestion problems shall be addressed with non-discriminatory market-based solutions which give efficient economic signals to the market participants and transmission system operators involved.*”
296. Both the principle of equal treatment and the principle of non-discrimination require that comparable situations must not be treated differently and that different situations must not be treated equally, unless such treatment is objectively justified⁴⁴.
297. In order to categorise situations as similar or different, they must be considered in the light of the aims of the measure in question: whether the requirement that situations must be comparable for the purpose of determining whether there is a breach of the principle of equal treatment has been met must be assessed in the light of all the elements which characterise them and, in particular, in the light of the subject matter and purpose of the national legislation which makes the distinction at issue⁴⁵.
298. Discrimination occurs where one person is treated less favourably than another one in a comparable situation on account of a specific distinguishing characteristic or on account of another characteristic which, however, is strictly related to the specific distinguishing characteristic. In the case of discrimination on grounds of nationality, the distinguishing characteristic relates to nationality⁴⁶.
299. The Board of Appeal finds that the scope of ACER Decision 30/2020’s RDCTCS equally applies to all NEs of the Core region. Cost sharing in larger BZs does not differ from cost sharing in smaller BZs within the Core region and the coordination of RAs in large BZs does not differ from the coordination of RAs in small BZs. Consequently, larger BZs are not discriminated against by ACER Decision 30/2020’s RDCTCS.
300. Moreover, applying RDCTCS to XNEs is precisely an instrument to avoid discrimination, as has been set out in Sub-Plea 1.1.7 of the First Consolidated Plea. Indeed, a narrower scope would imply that LFs on the smaller sub-set of XNEs (e.g. interconnectors) would contribute to cost sharing, whereas LFs of the same type on the excluded sub-set of XNEs (e.g. internal NEs) would not contribute to cost sharing.
301. ACER’s Defence provides a table with the results of the scenarios of All Core TSOs’ RDCTCS Experimentation Report (GREEN, GREEN SENSI 2, GREEN SENSI 4, BLUE, YELLOW), ACER’s own simulations of August 2020 using LCBM mapping (ACER SCEN.4 August 2020) and ACER’s own simulations of March 2021 using LCBM mapping (ACER SCEN. 4 March 2021)⁴⁷. The table demonstrates that a small BZ as Austria bears [10.8% to 21.5%] of the costs in the various scenarios whereas a large BZ as France bears [2% to 11.6%] of the costs in the various scenarios.

⁴⁴ Board of Appeal Decisions A-002-2018, paras 59-60; A-001-2019, para 159 and A-003-2019, para 90. See also Case C-390/15 RPO, ECLI:EU:C:2017:174, para 41 and C-336/19, Centraal Israëlitisch Consistorie van België e.a. ECLI:EU:C:2020:1031, para 85.

⁴⁵ Case C-193/17 Cresco Investigation, EU:C:2019:43, para 42; C-432/14 O, EU:C:2015:643, para 32 and C-451/16 MB, EU:C:2018:492, para 42.

⁴⁶ Board of Appeal Decisions A-001-2019, para 159 and A-003-2019, paras 90-100.

⁴⁷ Defence, para 212.

Scenario (%)	AT	BE	CZ	DE	FR	HR	HU	NL	PL	RO	SI	SK	TOTAL
GREEN	21,2%	0,3%	1,2%	68,9%	8,1%	-0,5%	0,0%	0,0%	0,9%	0,0%	-0,2%	0,2%	100,0%
GREEN SENS1_2	21,1%	0,4%	1,2%	69,8%	7,0%	-0,6%	0,1%	0,1%	1,0%	0,0%	-0,3%	0,2%	100,0%
GREEN SENS1_4	21,1%	0,3%	1,2%	66,7%	8,1%	-0,5%	0,0%	2,9%	0,3%	0,0%	-0,2%	0,2%	100,0%
YELLOW	21,5%	0,5%	-2,4%	57,9%	5,6%	-0,7%	0,2%	6,0%	11,2%	0,0%	-0,2%	0,4%	100,0%
BLUE	14,7%	1,4%	1,2%	56,5%	11,6%	1,3%	2,5%	3,6%	2,5%	1,2%	1,4%	2,0%	100,0%
ACER Scen. 4 LCBM August 2020	11,9%	0,3%	17,1%	60,4%	1,8%	0,2%	0,0%	3,5%	4,3%	0,0%	0,0%	0,6%	100,0%
ACER Scen. 4 LCBM March 2021	10,8%	0,1%	14,9%	61,5%	2,0%	0,3%	0,0%	7,2%	3,1%	0,0%	0,0%	0,2%	100,0%

Source: ACER's Defence, paragraph 212.

302. ACER Decision 30/2020 does not discriminate against BZs with high levels of renewable energy production.
303. Appellant I illustrates its claim with the example of Germany. As shown in the table of ACER's Defence above, some BZs have higher shares of RES than Germany whilst their cost contribution is lesser. The DE-LU BZ has a share of RES of 35% to 40%, whereas the Romanian BZ has a share of RES above 40% and the Croatian BZ has a share of RES above 70% according to ENTSO-E, Statistical Factsheet 2018⁴⁸. However, Germany's cost share (DE) in the various scenarios is of [56.5% to 69.8%], whereas the Romanian cost share (RO) is of [0% to 1.2%] and the Croatian cost share (HR) is of [-0.7% to 1.3%].
304. Climate change measures require investments that can only adequately be carried out in a Core region that is coordinated in terms of RAs. An adequate level of coordination in terms of RDCTs and OS can only be achieved through a corollary cost sharing system, as provided for in the RDCTCS. As set out above, the RDCTCS plays a role in the identification of the most effective CM measures under CACM aims to maximise CZC and ensure OS. In so doing, the ACER Decision 30/2020's RDCTCS has been designed in way that ensures an adequate level of investments in the long term and provides correct economic signals in accordance with 74 CACM and 16 ER, whilst fostering integration of Core CCR in terms of congestions. This adequate level of investments will foster, in the long term, correct investment initiatives by All Core TSOs and a smooth transition of the entire Core CCR towards decarbonisation.
305. As more renewable energy is connected, OS challenges will increase across the EU. Given the time lags associated with new transmission investment and BZ reconfiguration, short periods of high RDCT costs are possible. This means that it is particularly important to ensure co-ordination in the execution of RAs in order that overall costs to network users in the EU are minimised.
306. In this regard, the Board of Appeal refers to Recital 23 ER, which states: *While decarbonisation of the electricity sector, with energy from renewable sources becoming a major part of the market, is one of the goals of the Energy Union, it is crucial that the market removes existing barriers to cross-border trade and encourages investments into supporting infrastructure, for example, more flexible generation, interconnection, demand response and energy storage. To support this shift to variable and distributed generation, and to ensure that energy market principles are the basis for the Union's electricity markets of the future, a renewed focus on short-term markets and scarcity pricing is essential.*
307. Finally, given that Appellant I highlights the impacts of the ACER Decision 30/2020's RDCTCS on Germany, the Board of Appeal notes that, as demonstrated in ACER's Defence, reducing the scope of the RDCTCS does not necessarily lead to a reduction of the costs to be borne by DE-LU BZ to ensure security of the network. It will lead to the reduction of the costs to be classified as XNEs which can be shared with Core TSOs. The Board of Appeal refers to ACER's Defence:

Scenario	CATEGORY	DE COSTS (k €)
YELLOW SCENARIO: Only interconnectors constitute XBRNE	NON-CORE	3.5
	NON-XBRNE	1,085.5
	XBRNE	994.9

⁴⁸ Annex 29 to the Defence.

	TOTAL COSTS	2,083.9
BLUE SCENARIO: XBRNE are, in line with CCM, CNECs: - all CZ NEs - all internal NEs, defined by All Core TSOs, with a BZ-to-BZ PTDF \geq 5%	NON-CORE	30.1
	NON-XBRNE	702.4
	XBRNE	1,302.1
	TOTAL COSTS	2,034.6

Source: ACER's Defence, paragraph 212 and Annexes 24 and 35 to the Defence, with clarifications on the YELLOW and BLUE scenario by the Board of Appeal.

308. A comparison of the yellow and the blue scenario shows the following:

The blue scenario (CNECs) increases the scope in comparison with the yellow scenario (only interconnectors). However, when the scope of XBRNEs under the RDCTCS is reduced (i.e. a change from blue to yellow), costs for XBRNEs are reduced (from € 1,302.1 k (blue) to € 994.9 k (yellow)) and costs for NON-XBRNEs are increased (from € 702.4 k (blue) to € 1,085.5 € (blue)).

1.13 Due reasoning of the RDCTCS scope.

309. Appellant I⁴⁹ holds that ACER Decision 30/2020 fails to give reasons why RAs exercised on internal NEs should be included in the RDCTCS scope.

310. Appellant I⁵⁰ claims that ACER Decision 30/2020 should have included a reference to cases T-283/19 and T-631/19 on the definition of internal CNEs and that not doing so infringes ACER's duty to reason.

311. Appellant I and the Defendant agree that ACER has a duty to duly reason its decisions. This obligation is specifically foreseen in Article 14(7) ACER Regulation and also derives from Article 296 TFEU and the general principles of EU Law, including Article 41(2)(c) Charter. It has been confirmed by consistent case-law of European Courts⁵¹. Pursuant to this duty, the reasoning followed by the Agency must be disclosed in a clear and unequivocal fashion, firstly to make the persons concerned aware of the reasons for the measure and thus enable them to defend their rights and to verify whether or not the decision is well-founded and, secondly, to allow European Courts to exercise their powers to review the lawfulness of the measure⁵². The Board of Appeal refers to its earlier decision-making practice⁵³. Article 14(7) ACER Regulation states: "*Individual decisions of ACER shall state the reasons on which they are based for the purpose of allowing an appeal on the merits*".

312. Article 296 TFEU states: "*Legal acts shall state the reasons on which they are based and shall refer to any proposals, initiatives, recommendations, requests or opinions required by the Treaties.*"

313. Article 41(1) and (2)(c) Charter states: "*Every person has the right to have his or her affairs handled impartially, fairly and within a reasonable time by the institutions, bodies, offices and agencies of the Union. 2. This right includes: (...) (c) the obligation of the administration to give reasons for its decisions.*"

314. The Charter's procedural rights are not absolute rights. Their purpose is not to create abstract procedural obstacles, but to protect the rights of the addressees and other persons concerned by a decision, as provided for by the regulations applicable to such decision and by relevant

⁴⁹ Appeal I, Plea 1, para 99.

⁵⁰ Appeal I, Plea 1, para 123.

⁵¹ Case T-700/14 TVI v Commission EU:T:2017:447, para 79.

⁵² Case C-350/88 Delacre and Others v Commission ECLI:EU:C:1990:71, paras 15 and 16; Case T-217/01 Forum des migrants v Commission ECLI:EU:T:2003:106, para 68; and Case T-183/00 Strabag Benelux v Council EU:T:2003:36, para 55.

⁵³ Board of Appeal Decisions A-002-2018, paras 101, 128 and 131; A-006-2109 paras 106-142; A-001-2018, paras 112-118; A-001-2020, paras 240, 252 and 263; A-002-2020, paras 241, 253 and 264; A-003-2020, paras 206 and 235; A-007-2020, paras 66 and 99; and A-008-2020, paras 331-343.

case law⁵⁴. It is settled case-law that the degree of precision of the reasoning must be weighed against practical realities as well as against time and available technical facilities for taking such decision⁵⁵. The obligation to duly reason decisions is meant to allow its addressees to understand the content and reasoning of the decision and to enable them to challenge the decisions, as well as to allow for the control of this reasoning in the context of judicial review.

315. Section 6.2.2.1 of ACER Decision 30/2020 entitled “*Determination of cross-border relevant network elements eligible for cost sharing*” (paragraphs 64 until 81) contains ACER’s clear and unequivocal reasoning behind the RDCTCS scope, covering 5 full pages of the decision.
316. Taking account of the fact that the addressees of ACER Decision 30/2020 are TSOs, which are sufficiently acquainted with the technicalities of the RDCTCS and in the light of the extensive consultations and hearing process on the RDCTCS scope (see First Consolidated Plea), the reasoning of ACER Decision 30/2020 is adequate in relation to the RDCTCS scope. ACER reasoned that its determination of the RDCTCS scope was necessary to comply with the applicable framework, which required the RDCTCS to include cost-sharing solutions for actions of CB relevance.
317. Appellant I’s plea is detailed and demonstrates that it clearly and unequivocally understood the underlying reasoning of ACER Decision 30/2020 on the RDCTCS scope. Rather than evidencing a lack of reasoning, the Appellant’s plea expresses its dissatisfaction with the duly stated reasons set out in paragraphs 64-81 of the decision. This evidences that ACER provided Appellant I with a clear and unequivocal reasoning, which it was able to understand and is now able to rebut, even though it is dissatisfied with its contents.
318. As to Appellant I’s claim that ACER Decision 30/2020 should have included a reference to T-283/19 *Germany v ACER* and T-631/19 *BNetzA v ACER* on the definition of internal CNEs, the Board of Appeal observes that (i) these references relate to applications lodged by the German NRA against ACER Decision 02/2019, (ii) paragraph 71 of the ACER Decision 30/2020 expressly refers to ACER Decision 02/2019 to reason the scope of the RDCTCS and (iii) both cases are on-going and no judgments have been delivered by the GCEU with respect to said applications.
319. The Board of Appeal concludes that the Agency did not fail to adequately state reasons in ACER Decision 30/2020.
320. **It follows that the First Consolidated Plea must be dismissed as unfounded.**

Second Consolidated Plea – Amplification of the unlawful ROSC/RDCTCS linking by the RDCTCS’ priority of loop flows above the threshold.

321. Appellant I⁵⁶ claims that the impact of the unlawful linking of ACER Decision 30/2020’s RDCTCS to the Contested Decision’s ROSC is amplified by the fact that ACER Decision 30/2020 stacks LFs above the threshold as primary contributors when decomposing flows.
322. Appellant I claims, in this respect, that the prioritisation of LFs above the common threshold of 10% is unlawful because LFs are considered as primary contributors to the congestion. It stresses that the prioritisation of LFs above the threshold lacks a legal basis, violates Article 74(6)(a) and (b) CACM, discriminates against larger BZs and goes counter the promotion of renewable energy.

⁵⁴ Board of Appeal Decisions A-001-2017, para 124; A-001-2020, para 253; A-002-2020, para 254; A-007-2020, paras 67 and 101 and A-008-2020, paras 311 and 334.

⁵⁵ Board of Appeal Decisions A-001-2017, para 126; A-007-2020, paras 64, 67 and 101 and A-008-2020, paras 311 and 334.

⁵⁶ Appeal I, Plea 3, paras 159-181.

323. In its Defence⁵⁷, ACER responds that the prioritisation of LFs above the threshold (i) does not violate the principle of non-discrimination under Articles 16(1) ER and Articles 3(e) and 74(6)(i) CACM (no equal treatment of LFs and IFs is provided under Articles 16(8) and (13) ER); and (ii) does not violate Articles 74(6)(a), (b) and (f) and 3(g) CACM, does not violate the proportionality principle, and does not discriminate against larger BZs.

324. The Intervener intervenes in the Second Consolidated Plea on behalf of the Defendant.

2.1 Characteristics of the priority stack.

325. Article 2(2)(a), (o), (p) and (s) of ACER Decision 30/2020's RDCTCS defines the following flows:

“a) ‘allocated flow’ means a physical flow on a network element where the source and sink are located in different bidding zones;

(o) ‘internal flow’ means a physical flow on a network element where the source and sink and the complete network element are located in the same bidding zone;

(p) ‘loop flow’ means a physical flow on a network element where the source and sink are located in the same bidding zone and the network element or even part of the network element is located in a different bidding zone;

(s) ‘PST flow’ means a physical flow on a network element, which is caused by a PST with a tap position not in neutral position. PST flow is a cyclic flow, with the sink and source located at the same network element (the PST)”.

326. Article 7(6) and (7) of ACER Decision 30/2020's RDCTCS determine that LFs beyond a legitimate level (i.e. the level that could be expected without structural congestion in a BZ) should be identified as the primary contributors to the congestion on internal NEs, whereas IFs should be penalised only for the remaining volume of congestion:

“(6) In order to identify which flow components contribute to congestion and to which degree, all Core TSOs shall calculate the volume of overload, which shall be equal to the total flow on the eligible XNEC before the RAO, reduced by the maximum flow on that XNEC. The contributions to the volume of overload shall be calculated as follows:

(a) The burdening loop flows from bidding zones within the Core CCR above the individual threshold calculated pursuant to paragraph 4 or 5 shall be identified as the first contributor to the volume of overload. If the volume of these burdening loop flows is higher than the volume of overload, the contribution of each burdening loop flow from bidding zone within the Core CCR above the individual threshold shall be reduced proportionally such that the sum of contributions from burdening loop flows from bidding zones within the Core CCR above the individual threshold is equal to the volume of overload. The burdening loop flow contributions to the volume of overload shall be attributed to bidding zones that are the origins of the respective burdening loop flow components.

(b) The burdening internal flow shall be considered as the second contributor to the volume of overload. The burdening internal flow contribution shall be equal to the volume of overload reduced by burdening loop flow contributions calculated pursuant to (a) and shall not be higher than the burdening internal flow.

(c) The rest of the contribution to the congestion shall be identified with the following flow components in the order of following priority:

i. Burdening loop flow from outside the Core CCR;

ii. Burdening loop flows from bidding zones within the Core CCR below the individual threshold;

iii. Burdening allocated flow; and

iv. Burdening PST flow.

(d) The contribution to the congestion pursuant to points (b) and (c) shall be attributed to the XNE connecting TSO. In case the concerned XNE of the XNEC is a network element connecting two Core bidding zones, and XNE connecting TSOs have defined the same F_{max} for this element, the corresponding costs for such XNEC pursuant to points (b) and (c) shall be shared 50:50 between the two XNE connecting TSOs. In case the XNE connecting TSOs Page 16 of 19 on both sides have defined a different F_{max} for the concerned XNE, the costs for such XNEC pursuant to point (b) and (c) shall be shared in accordance with the following formula:

⁵⁷ Defence, paras 227-241.

$$S_{HI} = 0.5 \frac{\max(0, F_{total} - F_{max,HI})}{F_o}$$

$$S_{LO} = S_{HI} + \frac{\max(0, \min(F_{total}, F_{max,HI}) - F_{max,LO})}{F_o}$$

Equation 2

with

S_{LO}	Share of the costs for XNE connecting TSO which defined a lower F_{max} [%]
S_{HI}	Share of the costs for XNE connecting TSO which defined a higher F_{max} [%]
$F_{max,LO}$	Lower F_{max} [MW]
$F_{max,HI}$	Higher F_{max} [MW]
F_{total}	Total flow on XNEC [MW]
F_o	Volume of overload on XNEC which is equal to $F_{total} - F_{max,LO}$ [MW]

(7) The total costs attributed to XNEC as defined in Article 5(5) shall be split proportionally to the calculated contributions to congestion as defined in paragraph 6, where the burdening loop flow contributions are attributed to the concerned bidding zones and the remaining contributions to the XNE connecting TSO(s) pursuant to paragraph 6(d).”

327. Consequently, when deciding which flows cause a congestion on a NE, the flows are stacked on top of each other according to a prioritisation order, as follows:

- Burdening LFs from other BZs than the BZ where the XNEC is located within the Core CCR above the individual threshold
- Burdening IFs from the BZ where the XNEC is located
- Burdening LF from outside the Core CCR (within all bidding zones outside Core CCR)
- Burdening LFs from bidding zones within the Core CCR below the individual threshold
- Burdening AF from all cross-zonal exchanges within and outside the Core CCR
- Burdening PST flow from the effect of using all PSTs located within and outside the Core CCR

The flows exceeding 100% of the technical capacity of a NE are attributed to the TSO from whose transmission system the flows stem because they are considered as causing the congestion and are, hence, financially accountable in the RDCTCS. LFs above threshold are in the first position of the stack. This implies that LF polluting TSOs are the first ones to pay for RAs.

328. Paragraph 128 of ACER Decision 30/2020 depicts the flow prioritisation that is used for the RDCTCS as follows:

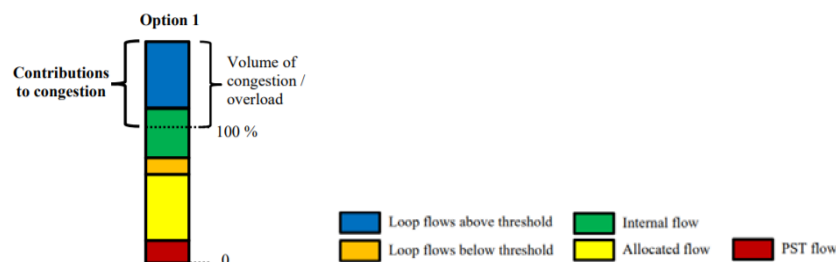

329. ACER Decision 30/2020’s RDCTCS prioritizes LFs over IFs in the stacking of the flow components. IFs may only be penalised for the remaining congestion after LFs above the threshold have been penalised.

2.2 The decision-making process leading-up to ACER Decision 30/2020.

330. ACER adopted ACER Decision 30/2020 on the basis of Article 6(10)(a) ACER Regulation and, to this end, it carried out the regulatory supervision of All Core TSOs’ RDCTCS Proposal under Article 74 CACM, which stipulates in Article 74(6)(f) that the RDCTCS needs to facilitate adherence to the general principles of CM as set out in Article 16 ER.

331. First, Article 7 of All Core TSOs' RDCTCS Proposal recognised a principle of stacking flow components according to a priority list. It acknowledged that only the flow components sorted on the basis of the priority list exceeding the maximum flow on NEs should be identified as contributors to congestion. The Proposal did not, however, include a proposed priority list: "Flow decomposition shall be performed on each congested XBRNE, either in base case or in a contingency case, and for each hour separately. In case the XBRNE list contains a network element with different contingencies causing overloads, the flow decomposition shall be performed on the contingency creating the overload which is the most difficult to relieve."

332. In the Explanatory Document accompanying All Core TSOs' RDCTCS Proposal⁵⁸, All Core TSOs unanimously stated that the prioritisation principles depended on the decisions made on other topics: "4.5.3 Prioritization. The final prioritisation principles depend on the decisions made on other topics. The aspects of prioritization which are taken into consideration are as following and not final:

- Loop flows above potential threshold are to be penalized first
- Coordinated market flows are to be penalized with low priority
- Penalization of the other flows (listed in the flow decomposition) is still to be determined

Only flow types above the technical limit are penalized. This goes along with a strict ordering of the flow types, which includes the reasoning that there are "good" and "bad" flow types. The following sketch illustrates the idea:

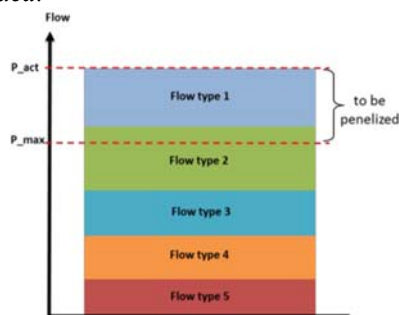

Figure 27: prioritization principle

The concrete ordering of the flows types should be based on a proper and agreed reasoning. This is a complex task and under discussion at the moment."

In addition, All Core TSOs held in the same Explanatory Document that for the prioritisation of the different flows, burdening LFs were considered to be the most critical flows, which should be penalised in the first place to avoid free-riding of neighbouring countries: "For the prioritisation of the different flows identified by the flow decomposition methodology, burdening loop flows are seen as the most critical flows. In accordance with the ACER recommendation and to avoid free-riding of neighbouring countries, those flows should be penalised in the first place in case a XBRNE is overloaded. Therefore loop flows are considered as polluters. They are also, individually, associated with only one bidding zone. The electricity network of the Core CCR is highly meshed and in combination with the zonal design of the EU Internal Energy Market a certain level of loop flows is therefore inevitable, even with the most ambitious grid investments. Indeed, such a goal could lead to the target which could be opposite to the goals of internal electricity market (lower investments in cross-border lines). Due to these reasons a threshold for the loop flows could be considered. The consequence of applying a threshold is that a part of the loop flows gets accepted and gets less highly prioritised as the remaining bigger share."

333. All Core NRAs evidenced divergent views as to whether IFs had to be considered as polluting flows or only LFs. A majority of Core NRAs held that "flows should be considered as polluter if and only if they result from transactions internal to bidding zones. In addition, would several categories of flows match this definition, the recast electricity regulation does not introduce any distinction between them. They shall be considered as equally polluting flows and put together at the top of the order stack. The costs induced by flows not resulting from transactions internal to a bidding zone should not be eligible to a sharing between TSOs. For the sake of clarity, TSOs may still need to identify separately loop flows and internal flows. Core NRAs acknowledge that such identification would be needed to correctly attribute each flow to the correct TSO. However, after such identification, all flows resulting from transactions internal to bidding zones should be

⁵⁸ Annex 13 to the Defence.

tackled equally.” Other Core NRAs considered “loop flows to be more polluting than internal flows”. These Core NRAs placed “loop flows at the top of the order stack”. One of these NRAs held that “the requirements set by Article 16(13) have to be combined with the requirement set by article 15(3) indicating that the costs linked to an action plan (and a decision of non-splitting a bidding zones – and here we refer to the costs related to loop-flows –) should be borne by the MS implementing an action plan. It can be expected that if internal flows and loop flows are considered equally polluting, a larger part of the costs related to solving structural internal congestion, will be transferred to other bidding zones. The extent of this distributional effect depends on the loop flow threshold (the larger the loop flow threshold, the more costs will be transferred to other bidding zones) and on the mapping. In the presence of action plans (and more generally in the presence of unsolved structural congestions – Article 15.1 and whereas 31) re-dispatching costs linked to internal congestions should not be transferred, not even partially, by the RAO process and consecutive cost sharing, to other TSOs owning transmission lines congested by the loop-flows generated by the same internal exchanges at the origin of the internal congestion.” Other NRAs did not share this view and objected that, just like LFs, IFs above a certain level could be the reflection of a structural congestion. For these NRAs, not penalizing such flows would result in transferring a part of a structural congestion and should be avoided.

334. In their Non-Paper (Section 1.9)⁵⁹, All Core TSOs but Appellant II (advocating an IF threshold in relation to APs) agreed that the IF threshold should be set at 0% or should be labelled as not-relevant for the cost sharing process. Appellant I did not make a statement about the priority stack.
335. The Board of Appeal concludes that, in carrying out its functions of regulatory supervision, ACER had to take account of the fact that All Core TSOs’ RDCTCS Proposal recognised the principle of a priority stack without setting a stack, whilst taking due account of the views of All Core NRAs. ACER had to ensure that All Core TSOs’ RDCTCS Proposal complied with the applicable regulatory framework.

2.3 The validity of prioritising LFs above the threshold in the priority stack.

336. First of all, the Board of Appeal refers to the First Consolidated Plea, in which it has been set out that the RDCTCS scope is not restricted to interconnectors (XNEs located on a BZB) or tie-lines. Consequently, the RDCTCS applies to both LFs and IFs. All XNEs should be included, also internal XNEs (which host and cause a variety of flows, not only IFs).
337. Second, the ACER Decision 30/2020 correctly places burdening LFs from other Core BZs than the Core BZ where the XNEC is located above the threshold as no.1 in the priority list of the flow decomposition and correctly places burdening IFs from Core BZ where the XNEC is located as no.2 in the priority list of the flow decomposition.
338. LFs above the threshold come as no.1 in the priority list. If the congestion is larger than the sum of all burdening LFs or if the LFs are below the legitimate threshold, then BZs with IFs will bear the remaining costs, given that these IFs also contribute to the congestion. In other terms, IFs are penalised only for the remaining volume of congestion.
339. This prioritisation duly reflects the fact that LFs above the threshold are the primary contributors to the congestion on internal NEs. This is not a quantitative criterion but a qualitative criterion. It is erroneous to claim that LFs and IFs are equally polluting flows.
340. LFs are unpredictable and caused in another BZ than the BZ of the LF-causing TSO. As set out in the First Consolidated Plea, Sub-Plea 1.1.2, LFs are unavoidable in a zonal model and that is why Article 16(13) ER requires a LF threshold, allowing a portion of acceptable LFs below the threshold and penalising LFs above the threshold on the basis of the PPP.
341. IFs are predictable and caused in the BZ of the IF-causing TSO. There is no need for an IF threshold because IFs are not unavoidable in a zonal model and because they are, in any

⁵⁹ ACER Decision 30/2020, para 25.

event, subject to the OPP. IFs are caused by the owner of the NE and, therefore, the polluter is also the owner. Applying the OPP or the PPP to IFs would place the cost burden on the same TSO.

342. Since IF-causing TSOs are financing the investment and maintenance of internal NEs via network fees or tariffs, whereas LF-causing TSOs are not, the LFs above the threshold (which is set at a level that could be expected without structural congestion in a BZ) should be identified as the primary contributor to the congestion. Indeed, network users trading within a BZ causing IFs pay network fees or tariffs to finance congested NEs inside their BZ, whereas network users trading with neighbouring BZs and causing LFs do not contribute to financing the congested NE outside their BZ.
343. All Core TSOs reached the same conclusion in the Explanatory Document accompanying All Core TSOs' RDCTCS Proposal⁶⁰. They held that burdening LFs were the most critical flows for the prioritisation of flows and had to be penalised in the first place to avoid free-riding of neighbouring countries: *"For the prioritisation of the different flows identified by the flow decomposition methodology, **burdening loop flows are seen as the most critical flows**. In accordance with the ACER recommendation and **to avoid free-riding of neighbouring countries**, those flows should be **penalised in the first place** in case a XBRNE is overloaded. Therefore loop flows are considered as polluters. They are also, individually, associated with only one bidding zone. The electricity network of the Core CCR is highly meshed and in combination with the **zonal design** of the EU Internal Energy Market **a certain level of loop flows is therefore inevitable**, even with the most ambitious grid investments. Indeed, such a goal could lead to the target which could be opposite to the goals of internal electricity market (lower investments in cross-border lines). Due to these reasons a threshold for the loop flows could be considered. The consequence of applying a threshold is that a part of the loop flows gets accepted and gets less highly prioritised as the remaining bigger share."* (emphasis added)
344. Placing IFs as no.1 in the priority list, alongside LFs above the threshold, would decrease the percentage of LFs above the threshold within the category of primary contributors to the congestion and remove them from the PPP. This observation was also made by the Intervener.
345. It would also be unfair to treat IFs equally to LF above the threshold because the IFs have not been preliminarily filtered through an IF threshold. The LFs that are no.1 in the priority list are LFs that are above a level that could be expected without structural congestion, i.e. a first filter has been applied as to their contribution to the congestion. IFs have not been sorted by a similar first filter as to their contribution to the congestion. Merging filtered LFs above the threshold with unfiltered IFs would, consequently, be unfair.
346. That is the reason why, as set out in All Core NRAs' Non-Paper⁶¹ and evidenced by the present appeals, the same stakeholders that opine that LFs above the threshold should not be prioritised above IFs in the order stack, also advocate an IF threshold. However, as set out above, an IF threshold would not only be based on a wrong rationale (because IFs do not share the same unpredictable nature as LFs) but would also have no other effect than diluting LF-causing TSOs' responsibility under the PPP (because IFs are subject to the OPP).
347. Placing IFs as no.1 in the priority list, alongside LFs above the threshold, would also be discriminatory because LFs above the threshold and IFs are different, on the one hand, due to their distinct nature – which has been set out above – and, on the other hand, due to the fact that LFs in no.1 of the priority list have previously been filtered through the threshold, whereas IFs as no.2 of the priority list are unfiltered.
348. The different nature of LFs above the threshold and IFs is clearly set out in paragraphs 132 ad 133 of ACER Decision 30/2020:
*"(132) On the other hand, ACER agrees with the majority of Core TSOs and regulatory authorities that **loop flows and internal flows cannot be treated equally** when identifying their contribution to congestion. This is*

⁶⁰ Annex 13 to the Defence.

⁶¹ ACER Decision 30/2020, para 23.

because the network users which are causing internal flows on internal network elements are actually financing the investment and maintenance of such internal network element via network fees or tariffs. These are users trading within a Member State and are using the domestic network, whose construction and operation has been financed by these users. On the other hand, users causing loop flows on internal network elements have not financed the investment and maintenance of such internal network elements via network tariffs, because these are users trading within one Member State, but the loop flows they create are flowing through the network of another Member State, where they do not pay the network fees or tariffs.

(133) Furthermore, the electricity networks within Member States have been primarily dimensioned and built to accommodate internal trading within Member States and cross-zonal trading, but it has not been dimensioned to accommodate significant loop flows from internal trading in other Member States. Thus, in most cases, the internal network elements are sufficient to accommodate domestic internal trade and cross-zonal trade, but when significant loop flows from internal trading within other Member State are added on top, these elements become congested.” (emphasis added)

349. Placing only LFs as no.1 in the priority list is in accordance with Article 16(13) ER.
350. Article 16(13) ER reflects the PPP: it mandates regulatory authorities to identify the cause of the congestion and mandates TSOs, upon regulatory supervision, to determine a LF threshold in order to allocate costs to TSOs that are causing LFs above the threshold.
351. Article 16(13) ER reads as follows: “When allocating costs of remedial actions between transmission system operators, regulatory authorities shall analyse to what extent flows resulting from transactions internal to bidding zones contribute to the congestion between two bidding zones observed (...)” (emphasis added)
352. Article 16(13) ER orders regulatory authorities to analyse to what extent flows resulting from transactions internal to BZs contribute to the congestion between 2 BZs observed. Consequently, it orders regulatory authorities to identify polluting flows causing congestion, i.e. LFs and IFs. Article 16(13) ER does not, however, state anywhere that LFs and IFs need to be treated equally. LFs can only be identified if they are distinguished from IFs. Article 16(13) ER requires that LFs be identified (and therefore distinguished from IFs) in order to allow TSOs, upon regulatory supervision, to determine a LF threshold aimed at penalising TSOs that are causing LFs above the threshold.
353. Article 16(13) ER does not mandate equality between polluting flows, i.e. it does not mandate equality between LFs and IFs. It neither contains nor prohibits a priority list. It merely mandates an identification of polluting flows and a LF threshold.
354. LF prioritisation is necessary to attain the objectives set by the CACM and the ER. As set out in Sub-Pleas 2.4 and 2.6, it creates the correct incentives to manage congestion and fosters the efficient development and operation of the EU interconnected system and electricity market in the long term (Article 74(6)(a) and (e) CACM). As set out in Sub-Plea 2.7, it is consistent with the responsibilities and liabilities of Core TSOs (Article 74(6)(b) CACM). As set out in Sub-Plea 2.5, it facilitates adherence to the general principles of CM (Article 74(6)(f) CACM). As set out in Sub-Plea 2.8, it ensures a fair distribution of costs and benefits between Core TSOs (Article 74(6)(c) CACM) and complies with the principles of transparency and non-discrimination (Article 74(6)(i) CACM).
355. Placing IFs as no.1 in the priority list, alongside LFs above the threshold, is not in accordance with the PPP, contained in both Article 16(13) ER and Article 76(1) SO because it dilutes LFs above the threshold and treats unequal flows equal in violation of the principle of non-discrimination. It does not create the correct incentives to manage congestion and does not foster the efficient development and operation of the EU interconnected system and electricity market in the long term. It is not consistent with the responsibilities and liabilities of Core TSOs. It does not ensure a fair distribution of costs and benefits between Core TSOs.

2.4 Prioritisation of LFs above the threshold contradicts the EU internal market fostering renewable energies.

356. Appellant I claims that LF prioritisation contradicts the EU goal of an internal electricity market fostering the integration of renewable energies.
357. Article 74(6)(e) CACM requires the RDCTCS “to facilitate the efficient long-term development and operation of the pan-European interconnected system and the efficient operation of the pan-European electricity market.”
358. Placing IFs as no.1 in the priority list, alongside LFs above the threshold, would not set fair rules for CB exchanges in electricity because (i) it decreases the percentage of LFs above the threshold within the category of primary contributors to the congestion, moving away from the PPP and (ii) it is discriminatory due to the different nature of LFs and IFs and the fact that LFs as no.1 of the priority list have previously been filtered through a threshold. This would not provide correct incentives to Core TSOs to manage congestion efficiently (including RAs) and to invest. TSOs of LF-causing BZs would be less incentivised to reduce LFs by means of BZ reconfiguration or network investments. Rather, placing IFs as no.1 in the priority list, alongside LFs above the threshold, would provide wrong incentives as TSOs creating LFs above the threshold need to be held accountable and reduce them. As correctly worded in paragraph 134 of the ACER Decision 30/2020, it would provide Core TSOs with insufficient incentives to reduce LFs. It would, at the same time, provide unfair incentives to LF-hosting TSOs to invest, despite the true reason for congestion being outside of their responsibility.
359. Placing IFs as no.2 of the priority list correctly provides incentives to LF-causing TSOs to manage their congestion problems and reduce LFs below the threshold. It also gives LF-hosting TSOs correct incentives to reduce IFs only in case the LFs are below the threshold. If there is still congestion on an internal NE when LFs are below the threshold, IFs are the reason for the congestion and should be penalised.
360. Moreover, introducing a corollary IF threshold would not only be based on a wrong rationale (because IFs do not share the same unpredictable nature as LFs) but would also have no other effect than diluting LF-causing TSOs’ responsibility under the PPP (because IFs are subject to the OPP).
361. In the long run, these incorrect incentives would undermine the attainment of an internal electricity market. They would hinder an efficient achievement of the objectives of the EU, a well-functioning, integrated electricity market and the emergence of a well-functioning and transparent wholesale market, contributing to a high level of security of electricity supply, and providing for mechanisms to harmonise the rules for CB exchanges in electricity, as per Article 1 ER.
362. Regarding Appellant I’s claim that LF prioritisation contradicts the promotion of RES, the Board of Appeal notes that climate change measures require investments that can only adequately be carried out in a Core region that is coordinated in terms of RAs. A correct identification of LFs above the threshold as primary contributors to the congestion is key to a cost sharing methodology that effectively coordinates RAs and provide Core TSOs with the correct incentives in terms of investments. These correct investment initiatives by All Core TSOs allow for a smooth transition of the entire Core CCR towards decarbonisation.

2.5 Prioritisation of LFs above the threshold infringes Article 16(13) ER and the PPP.

363. Appellant I alleges an infringement of the PPP because, if some BZs have permanent internal congestions in their grid or shift their internal congestions to the borders leading to internal NEs being close to the limit of their technical availability (close to 100%) and if LFs occur on said NEs, this might lead to an overload (over 100%) and the costs for RAs to remedy the

internal congestion would be borne by the TSOs that caused the LFs. In its view, the PPP is infringed because the cause is the internal congestion, not the LF.

364. Appellant I claims that if LFs occur on internal NEs being close to the limit of their technical availability this may result in an overload of these internal NEs and the costs for RA have to be borne by the TSO where the LP originate. It further alleges that it is possible that TSOs intentionally use topology measures to push internal flows on NEs that are anyway congested, given that LFs are automatically prioritised and that the LF polluting TSOs will hence bear the costs of a possible overload of this NE. In its Reply⁶², Appellant I reiterates that pushing internal congestions to the borders is one big obstacle on the way to a European internal electricity market.
365. The Board of Appeal refers to Sub-Plea 2.3 above, which sets out that placing IFs as no.2 of the priority list is in accordance with Article 16(13) ER and the PPP. As to the possibility for TSOs to intentionally use topology measures to push IFs on NEs that are anyway congested in order to make LFs pay for the costs of RAs necessary to relieve the physical congestion on these NEs - since they are the primary contributors -, the argument is flawed. First, TSOs cannot really push IFs because IFs come from activities of market participants and are beyond any TSO control and because IFs can only be mitigated by applying RAs which are subject to cost sharing. Second, even if it were possible, this intentional push is unlikely to occur given the monitoring obligations of Core TSOs as per Article 10(2) of ACER Decision 30/2020's RDCTCS, which provides that, in case one or more Core TSOs identify or suspect abusive behaviour (such as systematic forecast errors) or other negative impact of such forecasting, all Core TSOs shall further investigate whether the concerned TSO has gained any financial advantage from such behaviour. Third, incentives for such intentional pushes are relatively low. Indeed, if the congestion is larger than the sum of the burdening LFs due to this intentional push, IFs will contribute to the cost sharing. Furthermore, the calculation as to whether the congestion will be high enough to increase the share to be paid by LFs but not high enough to increase the share to be paid by IFs is extremely difficult to make given the unpredictable nature of LFs.
366. In Annex 100 to its Rejoinder, ACER includes two numerical examples to illustrate that the alleged intentional push is a flawed argument.
367. The Board of Appeal summarizes one of the examples below for the sake of completeness.
368. The example shows that there is clearly no rational reason or incentive for TSOs to intentionally push their IFs level because, by doing so, they only unnecessarily increase the total load on the NE, worsening the congestion, and eventually bear the costs of the remaining volume of overload.

Example 1 of Annex 100 to ACER's Rejoinder:

Due to a push of IFs, the congestion is larger than the sum of the LFs above the threshold, prioritised as no.1. As IFs are no. 2 of the priority list, the TSOs who pushed IFs will in fact end-up paying for the remaining volume of congestion because their IFs also contribute to the congestion.

Scenario 1 illustrates a NE without an intentional push of IFs:

⁶² Reply of Appellant I, para 60.

Scenario 1

Types of flows	MW
Market flows	500
Internal flows (TSO A)	600
Loop flows (TSO B)	150
Loop flows (TSO C)	-200
Total loading	1050

Fmax	1000
Overload	50
10% of Fmax	100
LFs > 10% thr	50
Remaining overload	0

- Fmax of NEs = 1000 MW
- total loading = 1050 MW (500 + 600 + 150 – 200 MW)
- overload = 50 MW (1050 – 1000 MW)
- 10% LF threshold => 100 MW (10% x 1000 MW) are legitimate LFs
- TSO A generates 600 MW burdening IFs.
- TSO C generates -200 MW relieving LFs, i.e. does not contribute to the congestion, i.e. bears 0 cost.
- TSO B generates 150 MW burdening LFs: 100 MW legitimate LFs + 50 MW illegitimate LFs stacked as no.1.

The remaining overload after subtracting burdening LFs is 0 (50 MW– 50 MW).
Hence, TSO B bears the entirety of the costs of the RA used to relieve congestion because IFs are stacked as no.2 and there is no remaining overload after no.1. TSO A bears 0 costs.

Scenario 2 illustrates a situation with an intentional push of IFs:

Scenario 2

Types of flows	MW
Market flows	500
Internal flows (TSO A)	700
Loop flows (TSO B)	150
Loop flows (TSO C)	-200
Total loading	1150

Fmax	1000
Overload	150
10% of Fmax	100
LFs > 10% thr	50
Remaining overload	100

- Fmax of NEs = 1000 MW
- total loading = 1150 MW (500 + 700 + 150 – 200 MW)
- overload = 150 MW (1150 – 1000 MW)
- 10% LF threshold => 100 MW (10% x 1000 MW) are legitimate LFs
- TSO A generates 700 MW burdening IFs.
- TSO C generates -200 MW relieving LFs, i.e. does not contribute to the congestion, i.e. bears 0 cost.
- TSO B generates 150 MW burdening LFs: 100 MW legitimate LFs + 50 MW illegitimate LFs stacked as no.1.

TSO A intentionally pushes its IF volume on the NE.
The remaining overload after subtracting burdening LFs is 100 MW (150 MW– 50 MW).
Hence, as IFs are stacked as no.2, and there is 100 MW remaining overload after no.1, TSO A bears 100 MW costs.

369. Appellant I also alleges that, under a correct application of the PPP, the TSO from whose network LFs stem are not polluters because LFs are the result of the physics of electricity and caused by the transactions of market participants (facilitated over networks) or integration of renewable energies.

370. The Board of Appeal refers to Sub-Plea 2.3 above. The fact that IF and LF have the same physical effect on a NE does not *per se* imply that they are equal and should be treated equally. Appellant I erroneously reverses the PPP and applies it to the polluting flow hosting TSOs, which Article 16(13) ER does not identify as polluters that should contribute to the RDCTCS. In the absence of IFs or LFs from polluting flow causing TSOs, the internal NEs of the polluting flow hosting TSOs would not be congested. Article 16(13) ER does not define pollution as a lack of maintenance or investment. Pollution is clearly defined as the contribution to the congestion through electricity flows.

2.6 Prioritisation of LFs above the threshold infringes Article 74(6)(a) CACM.

371. Article 74(6)(a) CACM states that the RDCTCS shall provide incentives to invest effectively.
372. Appellant I claims that prioritisation of LFs above the threshold provides wrong incentives. Appellant I states that it incentivizes a network expansion policy that remains focused on national interests because it allocates costs for RAs on internal NEs primarily to the TSOs in whose network LFs originate and not to the TSOs in whose network the internal congestion resides.
373. Appellant I claims that these wrong incentives impede a removal of internal congestions through incentives for network investments, contrary to Article 3(h) ER, which contains, as a general principle of the operation of electricity markets, a progressive removal of “*barriers to cross-border electricity flows between bidding zones in Member States and cross-border transactions on electricity markets and related services markets*”.
374. The Board of Appeal refers to Sub-Plea 2.4 above, which sets out that placing IFs as no.2 of the priority list creates correct incentives, whereas placing IFs as no.1 of the priority list, alongside LFs above the threshold, does not create correct incentives and, what is more, creates wrong incentives.
375. Moreover, placing IFs as no.1 of the priority stock would go hand-in-hand with an IF threshold based on a wrong rationale (because IFs do not share the same unpredictable nature as LFs) but would also have no other effect than diluting LF-causing TSOs’ responsibility under the PPP (because IFs are subject to the OPP).
376. The correct prioritisation of LFs above the threshold is in accordance with the objectives of the CACM of Article 3 ER given that it provides appropriate investment incentives to Core TSOs, “*in particular for long-term investments in a decarbonised and sustainable electricity system, energy storage, energy efficiency and demand response to meet market needs, and shall facilitate fair competition thus ensuring security of supply*” and contributes to the progressive removal of barriers to CB electricity flows between BZs in Member States and fosters CB transactions on the electricity market.

2.7 Prioritisation of LFs above the threshold infringes Article 74(6)(b) CACM.

377. Appellant I claims that prioritisation of LFs above the threshold is inconsistent with the responsibilities of the TSOs in whose networks the internal NEs are congested. In its view, those TSOs are responsible to invest in their internal network to avoid internal congestion.
378. Article 74(6)(b) CACM states that the RDCTCS shall be consistent with the responsibilities and liabilities of the TSOs involved.
379. As set out above in Sub-Pleas 2.3 and 2.4, placing IFs as no. 2 of the priority list provides correct incentives to Core TSOs in order to comply with their responsibilities and liabilities in accordance with Article 74(6)(b) CACM and duly take measures to reduce LFs below the threshold through various measures, e.g. network investments.

2.8 Prioritisation of LFs above the threshold infringes the principle of non-discrimination.

380. Appellant I⁶³ alleges that the prioritisation of LFs above the threshold discriminates against larger BZs because it over-penalises Core TSOs from large BZs.
381. Appellant I also alleges that the prioritisation of LFs above the threshold discriminates against Member States that foster renewable energy generation. Appellant I argues that the discriminatory dimension of the prioritisation of LFs above the threshold is perpetuated by the alleged excessive scope of the RDCTCS and too low common LF threshold: market barriers

⁶³ Appeal I, Plea 3, paras 159-181.

are perpetuated where LFs from other BZs – inherent to a zonal model - are penalised whilst not equally penalising IFs.

382. The Board of Appeal refers to Sub-Plea 1.12 above, which lists the legal provisions compelling ACER to comply with the principle of non-discrimination.
383. The Board of Appeal also refers to Sub-Plea 2.3, which sets out the rationale for placing IFs as no.2 of the priority list.
384. LFs and IFs are different in nature. LFs are unpredictable, caused in another BZ than the BZ of the LF-causing TSO and their unavoidable nature in a zonal market model justifies a threshold for acceptable LFs. IFs are predictable, caused in the BZ of the IF-causing TSO and do not require a threshold because they are not unavoidable in a zonal model and because they are, in any event, subject to the OPP. In addition, IF-causing TSOs are financing the investment and maintenance of internal NEs via network fees or tariffs, whereas LF-causing TSOs are not. Therefore, LFs and IFs are different in nature and should not be penalised equally. Furthermore, LFs stacked as no.1 are LFs that have been differentiated through the filter of a threshold in relation to their contribution to congestion, whereas IFs are unfiltered. This reinforces the fact that LFs above the threshold and IFs should not be penalised equally.
385. Consequently, given that LFs above the threshold and IFs are different, they should not be treated equally under the principle of non-discrimination. Different flows on similar XNEs should not be treated equally. This would be contrary to the principle of non-discrimination (Articles 20 and 21 Charter, Articles 3(e) and 74(6)(i) CACM, and Article 16(1) ER). LFs above the threshold are not over-penalised by the prioritisation foreseen by ACER Decision 30/2020. Additionally, treating LFs and IFs equal would provide wrong incentives to Core TSOs, as set out above in Sub-Plea 2.4, namely insufficient incentives to LF-causing TSOs to reduce LFs below the threshold and unfair incentives to LF-hosting TSOs to invest, despite the fact that the cause of the congestion lies outside of their responsibility.
386. Placing IFs as no.2 of the priority list does not discriminate against large BZs. ACER Decision 30/2020's RDCTCS applies equally to all BZs of Core CCR. Given that the priority list correctly identifies LFs above the threshold as primary contributors to the congestion, this has as a consequence that the cost sharing solution of ACER Decision 30/2020 will provide TSOs of BZs with a high level of LFs with necessary incentives to reduce LFs below the threshold in order to avoid high costs shares. In this respect, the Board of Appeal refers to ACER's own simulations, which were discussed with Core TSOs and NRAs during the proceedings leading-up to ACER Decision 30/2020⁶⁴.
387. These simulations show that large BZs do not necessarily generate large amounts of LFs above the threshold and do not lead to a larger cost share due to the prioritisation of LFs over IFs. ACER's simulations⁶⁵ are as follows:

Scenario (%)	AT	BE	CZ	DE	FR	HR	HU	NL	PL	RO	SI	SK	TOTAL
ACER Scen. 4 LCBM March 2021 ComTh10% IFprior0%*	10,8%	0,1%	14,9%	61,5%	2,0%	0,3%	0,0%	7,2%	3,1%	0,0%	0,0%	0,2%	100,0%
ACER Scen. 5 LCBM March 2021 ComTh10% IFprior100%**	10,4%	0,1%	14,1%	67,0%	1,8%	0,3%	0,0%	3,2%	3,0%	0,0%	0,0%	0,1%	100,0%
ACER Scen. 6 LCBM March 2021 ComTh10% IFprior50%***	10,6%	0,1%	14,4%	65,2%	1,8%	0,3%	0,0%	4,4%	3,1%	0,0%	0,0%	0,2%	100,0%

⁶⁴ ACER Decision 30/2020, para 23.

⁶⁵ Defence, para 236.

Source: ACER's Defence and Annex 34 to ACER's Defence.

* ACER Scenario 4 LCBM March 2021 ComTh10% IFprior0% is equivalent to the cost sharing methodology under ACER Decision 30/2020 with the updated input of March 2021.

** ACER Scenario 5 LCBM March 2021ComTh10% IFprior100%" provides cost sharing results where LFs and IFs are equally prioritised.

*** ACER Scenario 6 LCBM March 2021ComTh10% IFprior50%" provides cost sharing results where 50% of IFs are equally prioritised with LFs.

ACER Scen.4 is the scenario of ACER Decision 30/2020.

ACER Scen.5 includes all IFs as no.1 of the priority list alongside LFs above the threshold.

ACER Scen.6 includes 50% IFs as no.1 of the priority list alongside LFs above the threshold.

A comparison of all three scenarios leads to the following conclusions for the German BZ and the French BZ:

-German BZ: cost share increase of respectively 5.5% and 3.8% if IFs are totally or partially prioritised.

-French BZ: cost share decrease of 0.2% if IFs are totally or partially prioritised.

388. The above simulation evidences that a large BZ such as France has a considerably lower cost share than a large BZ such as Germany. Therefore, LF prioritisation does not discriminate against larger BZs *per se*. It also evidences, secondly, that a change in the priority – e.g. prioritising 50% of IFs or all IFs – does not significantly decrease France's cost share and would even increase Germany's cost share.

This leads to the conclusion that the important cost share of Germany is not due to the fact that it is a large BZ and that LF prioritisation discriminates against large BZs. The high cost share of Germany must therefore be related to other causes (these could be, *inter alia*, network deficiencies that generate a high level of LFs).

389. Placing IFs as no.2 of the priority list does not discriminate against BZs fostering RES, as set out in Sub-Plea 2.4.

390. Placing IFs as no.2 of the priority list does not discriminate against LF-causing TSOs, who would have to pay for costs that are provoked by IFs instead of LFs, as set out in Sub-Plea 2.3.

391. Placing IFs as no.2 of the priority stack does not discriminate in view of alleged requirements of equality between LFs and IFs to be found in Article 16(8) and (13) ER and the PPP, as set out in Sub-Plea 3.5.

392. Placing IFs as no.2 of the priority stack does not discriminate in relation to Article 74(6)(a) and (b) CACM, as set out in Sub-Pleas 2.4 and 2.7.

393. It follows that the Second Consolidated Plea must be dismissed as unfounded.

Third Consolidated Plea – Amplification of the unlawful ROSC/RDCTCS linking by the RDCTCS' threshold for acceptable loop flows.

394. Appellant I⁶⁶ claims that the impact of the unlawful linking of ACER Decision 30/2020's RDCTCS to the Contested Decision's ROSC is amplified by legitimate LF threshold set by ACER Decision 30/2020.

395. Appellant I alleges, in this respect, that the common threshold for acceptable LFs stipulated in Article 7(3) RDCTCS lacks a legal basis. It also infringes, in its opinion, Article 16(13) and (8) ER because (i) it is a common threshold for all BZBs and not an individual threshold for each BZB; (ii) it should have been based on a prior study by All Core TSOs; (iii) its value of 10% is too low whilst no long-term threshold has been set given the fact that Article 16(8) ER

⁶⁶ Appeal I, Plea 2, paras 126-158.

and Article 10(5) Core CCM foresee a 30%-threshold and account has to be taken of national characteristics, e.g. high renewable generation in larger BZs, which lead to comparably more LFs and (iv) is discriminatory towards large BZs.

396. In its Defence⁶⁷, ACER responds that the legitimate LF threshold is not discriminatory and that ACER Decision 30/2020 was duly reasoned in this regard.

397. The Intervener intervenes in the Third Consolidated Plea on behalf of the Defendant.

398. At the Oral Hearing, Appellant I challenged the one-size-fits-all nature of a common LF threshold and alleged that ACER's simulations are not future-proof, especially given the expectations of dynamic market developments (e.g. an increasing usage of RES).

3.1 Characteristics of the legitimate LF threshold.

399. Article 2(2)(a), (o), (p) and (s) of ACER Decision 30/2020's RDCTCS defines the following flows:

400. Article 7(1) to (5) of ACER Decision 30/2020's RDCTCS, entitled "*Distribution of costs on XNECs to TSOs*" contains a legitimate LF threshold:

"1. All Core TSOs shall use the flow components on each eligible XNEC to calculate the share of the total costs attributed to eligible XNEC that shall be attributed to each TSO from the Core CCR. The calculations shall consist of the following steps:

- i. Application of threshold(s) as described in paragraphs 2 to 5;*
 - ii. Identification of contributions to congestion as described in paragraph 6; and*
 - iii. Distribution of costs to bidding zones and TSOs as described in paragraphs 7 and 8.*
- 2. First, all Core TSOs shall split the burdening loop flow by each bidding zone within the Core CCR on each eligible XNEC in two parts: one part will define the burdening loop flow below the individual threshold and the other part the burdening loop flows above the individual threshold as defined in paragraph 4.*
- 3. To calculate the individual threshold for burdening loop flows from each bidding zone within the Core CCR on each eligible XNEC, all Core TSOs shall first calculate a common threshold for burdening loop flows from all bidding zones within the Core CCR on each eligible XNEC. This common threshold shall be equal to 10% of the F_{max} for each eligible XNEC.*
- 4. All Core TSOs shall calculate an individual threshold for burdening loop flows for each bidding zone within the Core CCR for each eligible XNEC, by dividing the common threshold as defined in paragraph 3 equally among all burdening loop flows from bidding zones within the Core CCR. If any burdening loop flow from any bidding zone within the Core CCR is below such calculated individual threshold, the individual threshold can be increased, such that the sum of all burdening loop flows (from all bidding zones within Core CCR) below the individual threshold is equal to the common threshold as defined pursuant to paragraph 3.*
- 5. The individual threshold pursuant to paragraph 4 is without prejudice to the determination of the level of loop flows that could be expected without structural congestion in a bidding zone and that is to be determined in accordance with Article 16(13) of the Electricity Regulation. Once this level is approved, it shall automatically replace the individual threshold as defined in paragraph 4."*

401. ACER Decision 30/2020's RDCTCS sets a **threshold for legitimate LFs**. In accordance with Article 16(13) ER and the PPP, costs for XRAs are allocated to those TSOs in whose BZs the flows that contributed to the congestion originated. Only LFs above the threshold are penalised: only costs caused by LFs above the threshold shall be borne solely by the TSOs that caused the LFs. Costs caused by LFs below the threshold are shared jointly between All Core TSOs.

402. The threshold for legitimate LFs of ACER Decision 30/2020's RDCTCS is **temporary**. It will automatically be replaced by a new threshold commonly determined by All Core TSOs and approved by All Core NRAs. ACER Decision 30/2020's RDCTCS does not set any time restrictions upon Core TSOs and NRAs to adopt a definitive legitimate LF threshold replacing the temporary threshold of ACER Decision 30/2020's RDCTCS. This implies that All Core TSOs and NRAs could adopt a definitive legitimate LF threshold before the actual

⁶⁷ Defence, paras 216-225.

implementation of the RDCTCS and avoid the implementation of the temporary threshold all in all. In other terms, ACER left it up to All Core TSOs to determine the legitimate LF threshold but, in the absence of such timely determination, ensured an interim solution in order not to jeopardise the implementation of the RDCTCS. The implementation of the interim solution could still be avoided by All Core TSOs as soon as they would agree on a definitive legitimate LF threshold to replace ACER's temporary threshold. All Core TSOs' could even agree to determine a legitimate LF threshold before the implementation of the RDCTCS in order to avoid any use of ACER's temporary threshold at all. The Board of Appeal notes that no steps have been taken by Core TSOs to determine a legitimate LF threshold since the adoption of ACER Decision 30/2020⁶⁸.

403. The threshold for legitimate LFs of ACER Decision 30/2020's RDCTCS is a **2-step threshold**. In a first step, a common threshold is set at **10% of the maximum capacity of each eligible XNEC in the Core region**. In a second step, the common threshold is divided between individual Core BZs in order to establish individual legitimate LF thresholds per Core BZ. In order to calculate the individual LF threshold per Core BZ, the common threshold is **split among Core BZs** that create LFs on the concerned NE. The splitting method splits the common LF threshold equally between BZs and provides that, if Core BZs have a level of LFs below the equally divided individual BZ LF threshold (negative value), this negative leftover value of usable but unused LFs can be redistributed to relieve Core BZs having a level of LFs above the threshold. Thus, the individual BZ LF threshold of the relieved Core BZs is increased proportionally to the unused leftovers of structurally not congested BZs. Ultimately the sum of all LFs from all Core BZs below the individual threshold is equal to the common LF threshold of 10%. As set out in the ACER Decision 30/2020 (paragraph 117), the aim is that BZs with a high level of LFs benefit from the fact that BZs with a low level of LFs are not utilising their individual threshold to the full extent. In so doing, ACER Decision 30/2020's RDCTCS aims at alleviating any disproportionate burden for larger BZs, e.g. the French BZ or the DE-LU BZ.

3.2 The decision-making process leading-up to ACER Decision 30/2020.

404. ACER adopted ACER Decision 30/2020 on the basis of Article 6(10)(a) ACER Regulation and, to this end, it carried out the regulatory supervision of All Core TSOs' RDCTCS Proposal under Article 74 CACM, which stipulates in Article 74(6)(f) that the RDCTCS needs to facilitate adherence to the general principles of CM as set out in Article 16 ER.

405. First, All Core TSOs' RDCTCS Proposal acknowledged the need for a threshold but did not provide further details as to how and to which flow components these thresholds are applied: *"Application of threshold: (a) Application of the threshold(s) per flow type may split individual flow types into two- sub-types"*.

406. In the Explanatory Document accompanying All Core TSOs' RDCTCS Proposal⁶⁹, All Core TSOs unanimously agreed on a LF threshold in Section 4.5. The discussion was centred on the parameters of the threshold:

"4.5.1 Treatment of loop flow.

Loop flows are unscheduled flows and make use of cross-border capacity (indirectly) prior to the Market Flows. For the prioritisation of the different flows identified by the flow decomposition methodology, burdening loop flows are seen as the most critical flows. In accordance with the ACER recommendation and to avoid free-riding of neighbouring countries, those flows should be penalised in the first place in case a XBRNE is overloaded¹⁵. Therefore loop flows are considered as polluters. They are also, individually, associated with only one bidding zone.

⁶⁸ Reply to the Third Request for Information of the Board of Appeal by Appellant I.

⁶⁹ Annex 13 to the Defence.

The electricity network of the Core CCR is highly meshed and in combination with the zonal design of the EU Internal Energy Market a certain level of loop flows is therefore inevitable, even with the most ambitious grid investments. Indeed, such a goal could lead to the target which could be opposite to the goals of internal electricity market (lower investments in cross-border lines). Due to these reasons a threshold for the loop flows could be considered. The consequence of applying a threshold is that a part of the loop flows gets accepted and gets less highly prioritised as the remaining bigger share. This option leads to the following questions:

On what parameter does the threshold apply?

(For the sake of clarity, please find an example in order to grasp the difference between the two possible options or parameters.)(..)”

407. Similarly, All Core NRAs unanimously agreed on the need for a threshold in All Core NRAs' Non-Paper, Section 2.3⁷⁰. The debate was not centred on whether to have a threshold but what the scope of application of the threshold had to be: *“In short, all Core NRAs agree that the flows below the defined threshold should be borne by the TSO responsible for the area to which the congested network element belongs.”*

408. Finally, in their Non-Paper (Section 1.9 *“Loop Flow Threshold”*), all Core TSOs also unanimously agreed on the need for a LF threshold⁷¹: *“In accordance with article 16(13) of REGULATION (EU) 2019/943, TSOs have to define the acceptable level of flows resulting from transactions internal to bidding zones. This level of acceptable loop flow is defined by a loop flow threshold.”* The debate was centred on the modalities of such threshold. None of Core TSOs, including Appellant I, tabled a legitimate LF threshold exceeding 15%:

“In accordance with article 16(13) of REGULATION (EU) 2019/943, TSOs have to define the acceptable level of flows resulting from transactions internal to bidding zones. This level of acceptable loop flow is defined by a loop flow threshold.

1.9.1 Core TSO positions

Regarding the loop-flow threshold, the different positions are as follow:

- 9 TSOs support a fix loop-flow threshold for all XBRNEs
 - APG, PSE CEPS, ELES, SEPS, Transelectrica: 5%
 - ELIA, MAVIR: several % up to 10%
 - HOPS: 3%
- 7 TSOs support a threshold per bidding zone border, but with the different design ideas
 - RTE, TenneT DE, TenneT NL, TransnetBW: LF threshold per XBRNE for each bidding zone border
 - Amprion, 50Hz, CREOS, TransnetBW: LF threshold per direction.”

409. The Board of Appeal concludes that, in carrying out its functions of regulatory supervision, ACER had to take account of the fact that All Core TSOs unanimously agreed on the need for a LF threshold, whilst taking due account of the views of All Core NRAs. Furthermore, ACER had to ensure compliance of All Core TSOs' RDCTCS Proposal with Article 74 CACM (especially Article 74(6)(f) CACM) and 16(13) ER).

410. ACER therefore asked All Core TSOs to set the legitimate LF threshold required by Article 16(13) ER in a 4 month deadline (by 20 August 2020). In the absence of compliance by All Core TSOs, ACER was under a duty to ensure compliance with Article 16(13) ER. ACER was not in a position to conduct the in-depth LF analysis required by Article 16(13) ER in a month time (from 20 August 2020, when TSOs did not provide requested analysis at the end of the hearing, until the 6-month deadline for ACER to take the RDCTCS decision, which ended on 27 September 2020). Such in-depth LF threshold study per BZ would have required ACER to first determine a situation with no structural congestion in any BZ. This would have required a protracted analysis of, *inter alia*, network investments and alternative BZ configurations which would address and remove all structural congestions in all Core BZs)

411. Consequently, ACER determined a temporary common threshold for legitimate LFs, following a rigorous analysis of the results from All Core TSOs' Experimentation Report, All

⁷⁰ ACER Decision 30/2020, para 23.

⁷¹ ACER Decision 30/2020, para 25.

Core TSOs' Non-Paper, All Core NRAs' Non-Paper and the results from ACER's own simulations using a variety of parameters.

412. ACER Decision 30/2020's RDCTCS clarifies that this threshold is temporary and will automatically be replaced by a new threshold commonly determined by All Core TSOs and approved by All Core NRAs. No steps have been taken by Core TSOs to determine a legitimate LF threshold since the adoption of ACER Decision 30/2020⁷².

3.3 The LF threshold requires a prior study and cannot be temporary.

413. Appellant I sets out that a temporary LF threshold triggers the risk that it becomes permanent in case All Core TSOs do not agree, "*permanently undermining NRAs' competences*". Rather than affecting negatively the need for a temporary LF threshold, this actually demonstrates the uncertainty of an agreement between Core TSOs in a short to medium term and, hence, reinforces the need for a temporary LF threshold up until that date.

414. The Board of Appeal observes that the bottom-up decision-making process provides that the initiative comes from the market (TSOs) but is supervised by regulatory authorities (NRAs or ACER) to ensure adequate regulatory compliance by private companies having private interests, in particular on CB issues. In the present case, All Core NRAs referred decision-making on All Core TSOs' RDCTCS Proposal to ACER on the basis of Article 9(11) CACM.

415. Given that All Core TSOs' RDCTCS Proposal did not contain a legitimate LF threshold as required by Article 16(13) ER, ACER had to ensure compliance with Article 74(6)(f) CACM and Article 16(13) ER. Article 16(13) ER requires that the legitimate LF threshold "*shall be jointly analysed and defined by all transmission system operators in a capacity calculation region for each individual bidding zone border, and shall be subject to the approval of all regulatory authorities in the capacity calculation region*". This is especially so because, as acknowledged by All Core NRAs and All Core TSOs, the legitimate LF threshold is indispensable for the RDCTCS.

416. ACER therefore asked All Core TSOs to set the legitimate LF threshold required by Article 16(13) ER in a 4 month deadline but, in the absence of compliance by All Core TSOs, it was under a duty to ensure compliance with Article 16(13) ER and therefore determined a temporary common threshold for legitimate LFs in the amount of 10%, following a rigorous analysis of the results from All Core TSOs' Experimentation Report, All Core TSOs' Non-Paper, All Core NRAs' Non-Paper and the results from ACER's own simulations using a variety of parameters and following an extensive consultation with Core TSOs and NRAs.

417. The Board of Appeal consequently finds that, even though no prior study was performed by All Core TSOs, ACER duly ensured compliance of All TSOs' RDCTCS Proposal with the applicable regulatory framework, especially Article 16(13) ER, in light of the indispensable nature of the legitimate LF threshold. The Board of Appeal notes, furthermore that, even though it is not based on a prior study by All Core TSOs, the LF threshold set by ACER is not arbitrary but based on a rigorous analysis, taking account of available experiments and surveys performed by All Core TSOs on the subject.

418. The 2-step approach of the legitimate LF threshold, set out in Article 7 of ACER Decision 30/2020's RDCTCS, is transparent and auditable. It is also consistent with the responsibilities and liabilities of TSOs because it allows Core TSOs precisely to comply with their responsibilities with respect to the RDCTCS under the CACM and the ER, despite their failure to reach an agreement during the decision-making process. The legitimate LF threshold of ACER Decision 30/2020 is fair and in line with the principle of non-discrimination, as will be set out below in Sub-Plea 3.7.

⁷² Reply to the Third Request for Information of the Board of Appeal by Appellant I.

419. Furthermore, the temporary nature is compliant with the principle of proportionality, given that ACER allows All Core TSOs and NRAs to set a definitive threshold, having had the benefit of performing an in-depth study on the subject. ACER left it up to All Core TSOs to determine the legitimate LF threshold but, in the absence of such timely determination, ensured an interim solution in order not to jeopardise the implementation of the RDCTCS and, what is more, the implementation of the interim solution could still be avoided by All Core TSOs as soon as they would agree on a definitive legitimate LF threshold to replace ACER's temporary threshold. ACER Decision 30/2020's RDCTCS clarifies that this threshold is temporary and will automatically be replaced by a new threshold commonly determined by All Core TSOs and approved by All Core NRAs. ACER Decision 30/2020's RDCTCS does not set any time restrictions upon Core TSOs and NRAs to adopt a definitive legitimate LF threshold replacing the temporary threshold of ACER Decision 30/2020's RDCTCS. All Core TSOs' could even agree to determine a legitimate LF threshold before the implementation of the RDCTCS in order to avoid any use of ACER's temporary threshold at all. The risk of the temporary threshold becoming permanent, as alleged by Appellant I, is fully left over to All Core TSOs and NRAs. The Board of Appeal notes that no steps have been taken by Core TSOs to determine a legitimate LF threshold since the adoption of the ACER Decision 30/2020⁷³. As indicated by the Intervener, All Core TSOs are under a duty to develop a proposal for amendment to improve all aspects of the RDCTCS not later than 12 months after its implementation, as per Article 12 of ACER Decision 30/2020's RDCTCS.

3.4 The LF threshold is set at an incorrect value.

420. Appellant I claims that the 10%-threshold is too low. It ties its claim for a threshold of at least 30% to its claim that the RDCTCS only applies to interconnectors: Article 16(8) ER explicitly allows the use of 30% of its capacity for LFs and reliability margins on interconnectors and no reliability margin needs to be used in the *ex post* process of cost sharing.
421. The Board of Appeal notes, with respect to the claim of Appellant I, that the scope of ACER Decision 30/2020's RDCTCS is not limited to interconnectors (see First Consolidated Plea).
422. The Board of Appeal also observes, with respect to the claims that the LF threshold should be tied to the 30%-split of Article 6(8) ER, that this is dealt with in Sub-plea 3.5 below.
423. The value of 10% is not the result of an arbitrary determination.
424. First, Article 16(13) ER requires that the legitimate LF threshold be determined in the absence of structural congestion. When determining the value of the legitimate LF threshold, the starting point is a situation whereby Core BZs did not experience structural congestion. This starting point unavoidably has an impact on the appropriate value of the threshold.
425. Second, the legitimate LF threshold of 10% relies on factually accurate, reliable and consistent evidence, which is based on the results from the analysis done by All Core TSOs in the context of the Experimentation Report, the results from ACER's own simulations and TSOs' expertise and NRAs' input through the exchanges done during consultations (e.g. All Core TSOs' RDCTCS Non-Paper, All Core NRAs' RDCTCS Non-Paper, consultation by ACER of All Core NRAs regarding a higher common LF threshold of 15%, etc.). Given that the initiative comes from the market - and in more specifically from All Core TSOs - in the bottom-up RDCTCS decision-making process, ACER had to take account of All Core TSO's Experimentation Report, whilst duly acknowledging its disclaimers and caveats. Moreover, ACER did not rely upon All Core TSOs' Experimentation Report to carry out its assessment of the legitimate LF threshold but carried out its own simulations. ACER's own simulations

⁷³ Reply to the Third Request for Information of the Board of Appeal by Appellant I.

were based on All Core TSOs' Experimentation Report but included specific parameters aimed at addressing the concerns that All Core NRAs and All Core TSOs had conveyed to ACER during the consultation. When carrying out its own simulations, ACER simulated the results of other scenarios (by modifying the parameters of this same model) in order to (i) carefully evaluate the different arguments from Core TSOs and NRAs and (ii) investigate alternative options that were compliant with Articles 74 CACM and 16 ER.

426. Third, the Board of Appeal observes that the Appellant challenges the value of 10% *per se*. In that respect, it has to be observed that the ultimate aim of penalising LFs above a threshold is in accordance with the PPP is to reduce LFs. Recital (27) ER states: “[...] Clear minimum levels of available capacity for cross-zonal trade need to be put in place in order to reduce the effects of loop flows and internal congestions on cross-zonal trade and to give a predictable capacity value for market participants”.
427. The more LFs in the network, the higher the risk of congestion in the BZs hosting these LFs, with all negative consequences for OS.
428. As set out above in the First Consolidated Plea, LFs are unavoidable in a zonal model. That is the reason why Article 16(13) ER requires All Core TSOs to agree on an acceptable level of LFs. And that is the reason why, in the absence of such agreement so far, ACER set a temporary legitimate LF threshold to allow due cost sharing of XRAs in Core CCR. The legitimate LF threshold is indispensable for the correct implementation of the RDCTCS and, consequently, for the correct implementation of the RDCT and the ROSC.
429. Setting the legitimate LF threshold at a very high level would not only jeopardise a correct implementation of the RDCTCS – providing the correct incentives to take all necessary measures to reduce LFs – but also undermine the implementation of the RDCT and the ROSC, threatening OS at Core level.
430. Setting the legitimate LF threshold at a very low level would fail to recognise that a degree of LFs are unavoidable in a zonal model.
431. The Board of Appeal acquiesces the observation of the Intervener, that the effect of increasing the LF threshold is more than linear: BZs that host LFs pay a larger part of the costs to solve congestions and, on top, they will see an increased frequency and volume of congestions. Therefore, every % increase in LF threshold in cost sharing moves the solution more than proportionately away from the PPP.
432. The Intervener provides the following example: *“Drawing a parallel with the capacity calculation process and the 70% requirement of the Article 16(8) of Electricity Regulation, – for demonstration – labelling 15% of the loop flows as acceptable comes to say that only 15% are left for both the reliability margin and the internal flows. Considering a usual value for the reliability margin of 10%, it would imply that only 5% would be left for internal flows. This highlights the fact that any threshold higher than 10% is in fact giving a preference to the loop flows (i.e. they pollute less) over the internal flows. With other words, a 10% threshold means that each country grid tariff payers offer only half of its transmission capacity to host internal exchanges and, offer for free, the second half for loop-flows, for the pollution. The maximum loop flow threshold acceptable is therefore 10% which leads more or less to an equal sharing between loop flows and internal flows.”*
433. The Board of Appeal observes that none of Core TSOs tabled the possibility of a 30% legitimate LF threshold during the decision-making process leading up to ACER Decision 30/2020. Section 1.9 *“Loop flow threshold”* of All Core TSOs' RDCTCS Non-Paper⁷⁴ summarizes the position of All Core TSOs on the appropriate legitimate LF threshold. None of Core TSOs, including Appellant I, tabled a legitimate LF threshold exceeding 15%:
“In accordance with article 16(13) of REGULATION (EU) 2019/943, TSOs have to define the acceptable level of flows resulting from transactions internal to bidding zones. This level of acceptable loop flow is defined by a loop flow threshold.
1.9.1 Core TSO positions
Regarding the loop-flow threshold, the different positions are as follow:

⁷⁴ ACER Decision 30/2020, para 25.

- 9 TSOs support a fix loop-flow threshold for all XBRNEs
 - o APG, PSE CEPS, ELES, SEPS, Transelectrica: 5%
 - o ELIA, MAVIR: several % up to 10%
 - o HOPS: 3%
- 7 TSOs support a threshold per bidding zone border, but with the different design ideas
 - o RTE, TenneT DE, TenneT NL, TransnetBW: LF threshold per XBRNE for each bidding zone border
 - o Amprion, 50Hz, CREOS, TransnetBW: LF threshold per direction”.

434. Fourth, the Board of Appeal notes that Appellant I does not challenge the numerical validity of the simulations performed by ACER which led to the value of 10%. Given the fact that none of Core TSOs had mentioned a need for a legitimate LF threshold in excess of 15%, ACER’s simulations logically did not cover a threshold in excess of 15%.

435. In light of the above, the Board of Appeal concludes that the value of the 10% LF threshold set by ACER Decision 30/2020 is not unlawful.

3.5 The LF threshold should not be fixed but floating and infringes Article 16(8) ER.

436. Appellant I alleges that Article 16(8) ER foresees that a percentage of 30% can be used freely for reliability margins, LFs and IFs, whilst 70% has to be made available for CB trade. Hence, the common threshold for acceptable LFs should, in their opinion, not be fixed but floating, at least until All Core TSOs perform a study to determine the acceptable LF threshold.

437. Appellant I claims that Article 16(8) ER does not contain a further distinction between the different sub-categories of non-CZ trade (reliability margins reflecting exchange uncertainties, LFs, IFs) but only states that up to 30% of the maximum interconnection capacity is freely available to the TSOs and can be used for non-CZ trade flows without any further specification. In Appellant I’s view, TSOs may use up to the maximum of 30% of the interconnection capacity for LFs.

438. Appellant I notes that, in particular, on interconnectors, there are no IFs and that therefore the 30% is to be used for LFs and reliability margins (which can be argued not to apply after the actual flow has taken place, *ex post*, during cost sharing).

439. Appellant I adds furthermore that a fixed threshold is inconsistent with Article 10(5) Core CCM, which foresees that a percentage of 30% of the technical capacity of a relevant network can be used freely for reliability margins, LFs and IFs, mirroring Article 16(8) ER. The common LF threshold of 10% threatens to create inconsistencies with Core CCM, hindering a smooth execution of the CC process.

440. Article 16(8) ER reads as follows: *“Transmission system operators shall not limit the volume of interconnection capacity to be made available to market participants as a means of solving congestion inside their own bidding zone or as a means of managing flows resulting from transactions internal to bidding zones. Without prejudice to the application of the derogations under paragraphs 3 and 9 of this Article and to the application of Article 15(2), this paragraph shall be considered to be complied with where the following minimum levels of available capacity for cross-zonal trade are reached: (a) for borders using a coordinated net transmission capacity approach, the minimum capacity shall be 70 % of the transmission capacity respecting operational security limits after deduction of contingencies, as determined in accordance with the capacity allocation and congestion management guideline adopted on the basis of Article 18(5) of Regulation (EC) No 714/2009; (b) for borders using a flow-based approach, the minimum capacity shall be a margin set in the capacity calculation process as available for flows induced by cross-zonal exchange. The margin shall be 70 % of the capacity respecting operational security limits of internal and cross-zonal critical network elements, taking into account contingencies, as determined in accordance with the capacity allocation and congestion management guideline adopted on the basis of Article 18(5) of Regulation (EC) No 714/2009. The total amount of 30 % can be used for the reliability margins, loop flows and internal flows on each critical network element.”*

441. The Board of Appeal notes, with respect to the claim of Appellant I, that the scope of ACER Decision 30/2020’s RDCTCS is not limited to interconnectors (see First Consolidated Plea).

442. The Board of Appeal also refers to the First Consolidated Plea, Sub-Pleas 1.1.2, 1.3 and 1.6, with respect to the relationship between the CC process and the RDCTCS.

443. First, the RDCTCS relates to XRAs, which are CM measures, whereas Article 16 ER contains the “*general principles of capacity allocation and congestion management*”, i.e. it covers a wider scope of CACM, i.e. CM and CA. Regardless of the fact that the ER has been adopted after the CACM, ACER Decision 30/2020’s RDCTCS needs to comply with the ER to the extent that they are CM principles, because RDCT are CM measures and not CA measures. Yet the general principles of Article 16 ER contain both CA and CM measures.
444. Second, the LF threshold complies with the general principles of CM contained in Article 16 ER, especially Articles 16(1) and 16(13) ER. ACER was under a regulatory obligation to set the LF threshold in order to ensure compliance with Article 16(13) ER and with its mandate to adopt the RDCTCS decision in accordance with the CACM overall. The LF threshold does not violate the principle of non-discrimination.
445. Third, Article 16(8) ER contains a general principle of CA (maximising interconnection capacity or CZC up to 70% and maintaining 30% for IFs, LFs and the reliability margin). This principle applies to the CC processes but not to the cost sharing process of the RDCTCS. Both processes are different and serve different goals at different points in time, as set out in the First Consolidated Plea. CC processes do not execute costly RAs and, therefore, no costs arise from them. If the 30%-threshold were to amount to the applicable threshold for LFs, there would be no need for Article 16(13) ER to require such threshold, and even less to require TSOs to perform an in-depth study to set the threshold per BZ.
446. Fourth, the 30% reserved for IFs, LFs and reliability margin is not a threshold but a cap. Article 16(8) ER codified the cap that had been set by ACER in ACER Decision 02/2019 (Article 10(5) of the DA CCM and Article 10(5) of the ID CCM). In ACER Decision 02/2019, ACER decided to cap IFs, LFs and reliability margin to a maximum of 30% of allowable flows on CNECs. This consequently required that at least 70% of maximal allowable flows on CNECs be reserved for CZ exchanges⁷⁵. The 70% is a *de minimis* requirement and TSOs have the obligation to maximise trade beyond 70% if they can, without applying costly RAs⁷⁶. ACER reached the conservative figure of 70% through a benchmarking exercise on limited data made available by the CWE and Nordic TSOs, which did not take account of XRA-related cost sharing process. Given its nature of a cap, the 30%-reserve for IFs, LFs and reliability margin is, as Appellant I correctly indicates, floating: if CZ exchanges take-up 85%, there will only be 15% left for IFs, LFs and reliability margin. The 10%-threshold is, due to the fact that it is a threshold, not flexible: LFs above the threshold are not considered legitimate whereas LFs below the threshold are considered legitimate. The wording of Article 16(13) ER is clear in that it requires a threshold and not a cap.
447. Fifth, the 30%-capacity for IFs, LFs and reliability margin is not in any way affected by the 10%-threshold for legitimate LFs.

3.6 The LF threshold infringes Article 74(6)(e) CACM.

448. Appellant I claims that BZs with large volume of LFs due to their high amount of RES will bear an unjustifiable financial burden in case of a common threshold for acceptable LFs of 10%, infringing the EU goal of an internal energy market that fosters RES. Article 74(6)(e) CACM requires the RDCTCS to “(e) facilitate the efficient long-term development and operation of the pan-European interconnected system and the efficient operation of the pan-European electricity market”.
449. The Board of Appeal notes that the objective of the RDCTCS is not to penalise TSOs from BZs with RES.

⁷⁵ ACER Decision 02/2019, para 124. Board of Appeal Decision A-001-2019, para 100.

⁷⁶ Board of Appeal Decision A-001-2019, para 115.

450. The LF threshold is imposed by the law and indispensable for the implementation of the RDCTCS and, given their interaction, the RDCT and the ROSC. An adequate level of coordination in terms of RDCTs and OS can only be achieved through a corollary cost sharing system, as provided for in the RDCTCS and, as set out in Sub-Plea 3.9, LF threshold is indispensable for the RDCTCS. The RDCTCS plays a role in the identification of the most effective CM measures under CACM and aims to maximise CZC and ensure OS. In so doing, ACER Decision 30/2020's RDCTCS has been designed in way that ensures an adequate level of investments in the long term and provides correct economic signals in accordance with 74 CACM and 16 ER, whilst fostering integration of Core CCR in terms of congestions. This adequate level of investments will foster, in the long term, correct investment initiatives by All Core TSOs and a smooth transition of the entire Core CCR towards decarbonisation. Adequate investments are therefore key with respect to RES.

3.7 The LF threshold infringes the principle of proportionality.

451. Appellant I⁷⁷ claims that ACER should have considered an alternative, less invasive threshold value, taking account of national characteristics, to the common threshold value for acceptable LFs of 10%. The absence of doing so violates, in its opinion, the principle of proportionality.
452. The Board of Appeal refers to Sub-Plea 1.1.9 above, which lists the legal provisions compelling ACER to comply with the principle of proportionality.
453. The Board of Appeal finds that ACER Decision 30/2020's RDCTCS does not exceed what is necessary to achieve the CACM's objective and is suitable to achieve that objective.
454. ACER Decision 30/2020's RDCTCS could not have ensured compliance with the Article 74 CACM and Article 16(13) ER without a legitimate LF threshold. An adequate level of coordination in terms of RDCTs and OS can only be achieved through a corollary cost sharing system, as provided for in the RDCTCS and, as set out in Sub-Plea 3.9, a legitimate LF threshold is indispensable for the RDCTCS.
455. Given that All Core TSOs' RDCTCS Proposal did not contain a legitimate LF threshold as required by Article 16(13) ER, ACER had to ensure compliance with Article 16(13) ER as per Article 74(6)(f) CACM. It therefore asked All Core TSOs to set the legitimate LF threshold required by Article 16(13) ER in a 4 month deadline but, in the absence of compliance by All Core TSOs, it was under a duty to ensure compliance with Article 16(13) ER and therefore determined a temporary common threshold for legitimate LFs.
456. In the absence of a threshold for legitimate LFs, ACER Decision 30/2020's RDCTCS could not have ensured compliance with the Article 74(6)(b) CACM, which requires the RDCTCS to "*be consistent with the responsibilities and liabilities of the TSOs involved*". All Core TSOs had the responsibility to determine a threshold for legitimate LFs. The absence of an agreement forced ACER to determine a temporary LF threshold that would disappear as soon as All Core TSOs would determine a definitive LF threshold (which All Core TSOs could do prior to the implementation of the RDCTCS in order to avoid that ACER's temporary LF threshold by used at all).
1171. In the absence of a threshold for legitimate LFs, ACER Decision 30/2020's RDCTCS could not have ensured compliance with Article 74(6)(e) CACM, requiring the RDCTCS to "*facilitate the efficient long-term development and operation of the pan-European interconnected system and the efficient operation of the pan-European electricity market*". Both the efficient long-term development and operation of the EU interconnected system and the efficient operation of the EU electricity market require that the costs of RDCT actions be shared at a regional level among

⁷⁷ Appeal I, Plea 2 , para 153.

TSOs through a cost sharing solution. And a legitimate LF threshold is indispensable in order to create a RDCTCS in line with the PPP, as mandated by the ER.

1172. In the absence of a threshold for legitimate LFs, ACER Decision 30/2020's RDCTCS could not have ensured compliance with the Article 74(6)(f) CACM, which requires the RDCTCS to "*facilitate adherence to the general principles of congestion management as set out in Article 16 ER*". Article 16(13) ER expressly requires that a "*level*" is set below which structural congestion can be expected in a BZ. Given that All Core TSOs had not (yet) reached an agreement on the legitimate LF threshold, ACER was under a regulatory obligation to set a temporary LF threshold in order to ensure compliance with the CACM and the ER. The absence of the temporary LF threshold set by ACER would have thwarted the application of the PPP, at the heart of the cost sharing methodology of the RDCTCS. The PPP is at the heart of the cost sharing methodology of the RDCTCS⁷⁸.
1173. The absence of the temporary LF threshold set by ACER would also have jeopardised the *effet utile* of Article 74 CACM, given that the threshold for legitimate LFs is as an indispensable part of the RDCTCS, as expressly recognised by ACER Decision 30/2020. Paragraph 109 of ACER Decision 30/2020 states: "*The threshold for loop flows is an indispensable part of the cost sharing methodology, because Article 16(13) of the Electricity Regulation establishes a principle by which loop flows, which are expected in bidding zones without structural congestions should not be considered as contributing to congestion and therefore penalised. This principle reflects the fundamental nature of zonal electricity market model that even in an optimal bidding zone configuration, some levels of loop flows would still persist and are therefore inherent in any zonal market model. Article 16(13) of the Electricity Regulation therefore establishes a rule by which this normal level of loop flows is legitimate and should not be penalised.*"
1174. In the absence of ACER's determination of a temporary threshold for legitimate LFs, a deadlock situation could have occurred whereby the inability for All Core TSOs to reach an agreement could have led to the consequence that no adequate RDCTCS could have been implemented.
1175. ACER had two options when it faced a lack of compliance of All Core TSOs' RDCTCS Proposal with the requirements of Article 16(3) ER: either to specify a legitimate LF threshold itself or instead to require All Core TSOs propose to specify a legitimate LF threshold. ACER chose the latter, in line with the principle of proportionality, and asked All Core TSOs to specify a legitimate LF threshold within a 4-month deadline, which was reasonable to enable ACER to subsequently supervise its compliance with the applicable regulatory framework and approve it. However, in the absence of an agreement between All Core TSOs, ACER was under a duty to ensure that the RDCTCS complied with the applicable regulatory framework, including Article 16(13) ER and contained a legitimate LF threshold. It therefore determined a temporary common threshold for acceptable LFs in the amount of 10%, following a rigorous analysis of the results from All Core TSOs' Experimentation Report, All Core TSOs' Non-Paper, All Core NRAs' Non-Paper and the results from ACER's own simulations using a variety of parameters. ACER Decision 30/2020's RDCTCS clarifies that this threshold is temporary and will automatically be replaced by a new threshold commonly determined by All Core TSOs and approved by All Core NRAs. ACER Decision 30/2020's RDCTCS does not set any time restrictions upon Core TSOs and NRAs to adopt a definitive legitimate LF threshold replacing the temporary threshold of ACER Decision 30/2020's RDCTCS. This implies that All Core TSOs and NRAs could adopt a definitive legitimate LF threshold before the actual implementation of the RDCTCS and avoid the implementation of the temporary threshold all in all.

⁷⁸ See ACER Decision 30/2020, para 109.

1176. In other terms, ACER left it up to All Core TSOs to determine the legitimate LF threshold but, in the absence of such timely determination, ensured an interim solution in order not to jeopardise the implementation of the RDCTCS and, what is more, the implementation of the interim solution could still be avoided by All Core TSOs as soon as they would agree on a definitive legitimate LF threshold to replace ACER's temporary threshold. All Core TSOs' could even agree to determine a legitimate LF threshold before the implementation of the RDCTCS in order to avoid any use of ACER's temporary threshold at all.
457. Consequently, the determination of a LF threshold in ACER Decision 30/2020's RDCTCS is necessary and suitable to attain the objectives of the applicable regulatory framework.
458. The fact that this threshold was determined in a 2-step LF approach, with a common 10% threshold subsequently split among individual BZs, is also necessary and suitable to attain the objectives of the applicable regulatory framework.
459. As set out above in Sub-Plea 3.4, the LF threshold has been set in accordance with a situation without structural congestion as required by Article 16(13) ER and its determination was based on a robust technical analysis. As set out in Sub-Plea 3.3, the temporary nature of the threshold underlines its compliance with the principle of proportionality given that Core TSOs and Core NRAs are able to remove it at any moment and replace it by a commonly agreed legitimate LF threshold upon an in-depth study. The Board notes that, since the adoption of the ACER Decision 30/2020, no steps have been undertaken by Core TSOs to define a legitimate LF threshold⁷⁹. Finally, the Board of Appeal refers to Sub-Plea 3.5 as regards the relationship between the 30%-cap of Article 16(8) ER and the 10%-threshold of the ACER Decision 30/2020's RDCTCS, especially to the fact that, if the 30%-threshold were to amount to the applicable threshold for LFs, there would be no need for Article 16(13) ER to require such threshold, and even less to require TSOs to perform an in-depth study to set the threshold per BZ.

3.8 The LF threshold infringes the principle of non-discrimination.

460. Appellant I⁸⁰ claims that larger BZs tend to have more LFs than smaller BZs and that the determination of a low common threshold for acceptable LFs at 10%, without differentiating between specific characteristics of national markets, discriminates against larger BZs. Appellant I illustrates this with the German BZ: because of its large volume of LFs due to its high amount of renewable energy, it will bear an unjustifiable financial burden in case of a common threshold for acceptable LFs of 10%. This, in its view, discriminates against German TSOs and network users and infringes the EU goal of an internal energy market.
461. The Board of Appeal refers to Sub-Plea 1.12 above, which lists the legal provisions compelling ACER to comply with the principle of non-discrimination.
462. The Board of Appeal expresses the preliminary observation that Article 16(13) ER requires a legitimate LF threshold in order to discriminate between LFs below the threshold and LFs above the threshold, and penalise the latter. Hence, Appellant I's claim of an infringement of the principle of non-discrimination applies to the setting of the value of a threshold, the aim of which is to discriminate, in order to accept some LFs and penalise others on the basis of the PPP.
463. As set out above in Sub-Plea 3.4, the appropriate value for the legitimate LF threshold is conditioned by the legal requirement of Article 16(13) ER that it be determined in the absence of structural congestion. When determining the value of the legitimate LF threshold in the first step, the starting point is a situation whereby Core BZs do not experience structural

⁷⁹ Reply to the Third Request for Information by the Board of Appeal by Appellant I.

⁸⁰ Appeal I, Plea 2, paras 150-158.

congestion. The rationale of the test is that BZs without structural congestion do not bear the costs caused by BZs with structural congestion. This first step of the determination of the LF threshold is not discriminatory: it applies equally to all BZs of the Core CCR.

464. As set out above in Sub-Plea 3.1, the common LF threshold set in the first step is subsequently split between individual Core BZs and the splitting method has precisely been chosen to duly take account of structural congestion and avoid discrimination between BZs (proportionate splitting would be discriminatory).
465. Consequently, the setting of the value of the threshold in each of the steps of the two-step approach is not discriminatory.
466. The fact that, as a result of the legitimate LF threshold, BZs with a high level of LFs (above the threshold) will bear a high part of the costs and BZs with a low level of LFs (below the threshold) will not bear any costs, complies with the requirement of Article 16(13) ER. That is precisely what threshold has been set for.
467. Large BZs are not discriminated against by the value of the LF threshold. Appellant I's claim that a higher LF threshold value than 10% should be set for larger BZ would infringe the requirement of Article 16(13) ER. The law requires that the threshold is determined in a situation of BZs without structural congestion, i.e. a situation whereby LFs and internal congestions are taken out of the equation. Any claim of the infringement of the principle of non-discrimination must be assessed in a structural congestion free situation.
468. Proof that large BZs are not discriminated against by the value of the LF threshold is that, as set out in the table Sub-Plea 2.8 above, the cost share of France for coordinated RAs taken during 10 timestamps of All Core TSOs' RDCTCS Experimentation Report under ACER scenario 4 (the scenario of ACER Decision 30/2020) amounts to 2%. The French BZ constitutes a large BZ.
469. The fact that Germany (DE-LU) will likely bear a high cost share is not due to the fact that it is a large BZ but due to the fact Article 16(13) ER requires the LF threshold to be determined in the absence of structural congestion, as shown in Sub-Plea 3.4. If Germany is characterised by a situation of structural congestion with a high level of LFs, i.e. a level that is above the situation in which a BZ is considered as without structural congestion, it is likely to bear a high cost share. The LF threshold aims precisely at penalising LFs above the threshold in a situation without structural congestion and, consequently, at incentivising appropriate measures to reduce LFs to a level below the threshold, e.g. by means of network investments or BZ reconfigurations.
470. Furthermore, the splitting method of the common LF threshold between BZs, foreseen in the ACER Decision 30/2020's RDCTCS, softens any disproportionate impact that BZs with structural congestion and a high level of LFs may experience, whilst correctly relieving BZs without structural congestion and a low level of LFs: BZs with structural congestion and a high level of LFs may benefit from the fact that BZs without structural congestion and a low level of LFs are not utilising their individual LF threshold to the full extent.
471. Also, the legitimate LF threshold of ACER Decision 30/2020 does not discriminate against BZs with high RES levels.
472. First, All Core TSOs are subject to identical environmental targets.
473. Second, as set out above in the First Consolidated Plea, climate change measures require investments that can only adequately be carried out in a Core region that is coordinated in terms of RAs. An adequate level of coordination in terms of RDCTs and OS can only be achieved through a corollary cost sharing system, as provided for in the RDCTCS and, as set out in Sub-Plea 3.9 below, a LF threshold is indispensable for the RDCTCS.

474. As set out above, the RDCTCS plays a role in the identification of the most effective CM measures under CACM. It aims to maximise CZC and ensure OS. ACER Decision 30/2020's RDCTCS has been designed in way that ensures an adequate level of investments in the long term and provides correct economic signals in accordance with 74 CACM and 16 ER, whilst fostering integration of Core CCR in terms of congestions. This adequate level of investments will foster, in the long term, correct investment initiatives by All Core TSOs and a smooth transition of the entire Core CCR towards decarbonisation.
475. Appellant I⁸¹ argues that the discriminatory dimension of the too low common LF threshold of ACER Decision 30/2020's RDCTCS is perpetuated by the alleged excessive scope of the RDCTCS (see, First Consolidated Plea): the more internal NEs are included into the RDCTCS, the more LFs above threshold will be taken into account in the RDCTCS.
476. Appellant I also argues that the discriminatory dimension of the prioritisation of LFs above the threshold is perpetuated by the alleged excessive scope of the RDCTCS and too low common LF threshold: market barriers are perpetuated where LFs from other BZs – inherent to a zonal model - are penalised whilst not equally penalising IFs.
477. In its Reply⁸², Appellant I reiterates that the combination of the 3 errors in law lead to a perpetuation of discrimination of Appellant I.
478. Having found no infringement in the First Consolidated Plea and having found no infringement of the principle of non-discrimination in Second and Third Consolidated Pleas (Sub-Pleas 2.8 and 3.8), the Board of Appeal does not identify a cumulative effect of infringements.

3.9 ACER's competences when determining the LF threshold.

479. Appellant I⁸³ claims that there was no legal basis for ACER to set a common LF threshold neither in CACM nor in ER. It also claims that ACER was not the competent authority to decide on the threshold for legitimate LFs because Article 16(13) ER explicitly puts the NRAs in charge of deciding upon an individual LF threshold for each BZB. Also, this interim threshold set by ACER bears, in its view, the threat of permanently undermining the NRAs' competences because Article 16(13) ER does not set any timing for TSOs and NRAs to determine the individual LF thresholds.
480. Article 5(1) TEU states that *"The limits of Union competences are governed by the principle of conferral. The use of Union competences is governed by the principles of subsidiarity and proportionality."*
481. Article 5(2) TEU states that *"Under the principle of conferral, the Union shall act only within the limits of the competences conferred upon it by the Member States in the Treaties to attain the objectives set out therein. Competences not conferred upon the Union in the Treaties remain with the Member States."*
482. The principle of conferral set out in Article 5(1) and (2) TEU is a fundamental principle of EU law, according to which the EU acts only within the limits of the competences that EU Member States have conferred upon it in the Treaties. These competences are defined in Articles 2 to 6 TFEU. There are 4 types of competences: (i) exclusive competences (Article 3 TFEU): only the EU can act in these areas e.g. customs union & trade policy; (ii) shared competences between the EU and EU countries (Article 4 TFEU): EU countries can act only if the EU has chosen not to act, e.g. cohesion policy, energy & environment; EU countries may ask the Commission to repeal an adopted legislative act in one of the shared areas so as to better ensure compliance with the principles of subsidiarity and proportionality (Declaration No 18 annexed to the Treaty of Lisbon); (iii) special competences (Article 5

⁸¹ Appeal I, Plea 2, paras 155-156.

⁸² Reply of Appellant I, paras 62-64.

⁸³ Appeal I, Plea 2, paras 134-139.

TFEU): the EU can take measures to ensure that EU countries coordinate their economic, social and employment policies at EU level, e.g. economic policy; and (iv) supporting competences (Article 6 TFEU): the EU can only intervene to support, coordinate or complement the action of EU countries, e.g. culture & tourism. Competences not conferred on the EU by the Treaties thus remain with EU countries. The principle of conferral implies that every secondary legal act must have a legal basis in specific Treaty articles or primary EU law, subject to control by the European Courts. While the principle of conferral governs the limits to EU competences, the use of those competences is governed by the principles of subsidiarity and proportionality.

483. Under the principle of conferral, energy is a shared competence (Article 4 TFEU): the EU and EU countries are able to legislate and adopt legally binding acts. EU countries exercise their own competence where the EU does not exercise, or has decided not to exercise, its own competence.
484. ACER's competences are shared competences within the meaning of Article 4 TFEU. When exercising these EU competences, it is subject to two fundamental principles laid down in Article 5 TEU, namely the principle of proportionality (the content and scope of EU action may not go beyond what is necessary to achieve the objectives of the Treaties) and the principle of subsidiarity (in the area of its non-exclusive competences, the EU may act only if — and in so far as — the objective of a proposed action cannot be sufficiently achieved by the EU countries, but could be better achieved at EU level).
485. ACER took ACER Decision 30/2020 on the basis of Article 6(10) of the ACER Regulation: *“ACER shall be competent to adopt individual decisions on **regulatory issues having effects on cross-border trade or cross-border system security** which require a joint decision by at least two regulatory authorities, (...)”*. (emphasis added).
486. That is the legal basis of ACER Decision 30/2020, including the RDCTCS in its Annex 1. That is, therefore, the legal basis of Article 7 (Distribution of costs on XNECs to TSOs) of the RDCTCS, where a common threshold for acceptable LFs of 10% is temporarily determined. ACER Decision 30/2020 is not silent on the legal basis: Section 3 of ACER Decision 30/2020 entitled *“ACER's competence to decide on the Proposal”*, in paragraphs 12 to 18 of ACER Decision 30/2020, sets out the legal basis for ACER Decision 30/2020.
487. When adopting ACER Decision 30/2020, ACER was therefore competent to decide on the regulatory issues of the RDCTCS in order to avoid a deadlock situation deriving from a disagreement between All Core NRAs within the set deadline. As set out in Recital (10) ACER Regulation, *“ACER was established to fill the regulatory gap at Union level and to contribute towards the effective functioning of the internal markets for electricity and natural gas,”*
488. ACER exercised its shared competences regarding energy on the basis of Article 6(10) of the ACER Regulation. ACER did not exceed its competence. ACER's competence on the basis of Article 6(10) of the ACER Regulation has to be situated in a bottom-up decision-making process foreseen by EU energy regulation. In this bottom-up decision-making process, the role of the regulators – either the NRAs or ACER – is to assess whether TSO proposals comply with the applicable regulatory framework in order to subsequently grant regulatory approval. This is in accordance with the Board of Appeal's earlier case-law⁸⁴.
489. Indeed, the bottom-up decision-making process provides that the initiative comes from the market (TSOs) but is supervised by regulatory authorities (NRAs or ACER) to ensure

⁸⁴ Board of Appeal Decisions A-004-2019, para 233; A-001-2020, paras 14, 102, 106, 138, 139, 160, 161, 184, 188, 234 and 258; A-002-2020, paras 14, 102, 106, 139, 140, 161, 162, 185, 189, 235 and 259; A-003-2020, para 14; A-007-2020, paras 5, 14, 68, 103 and 104; and A-008-2020, paras 19, 113-115, 138, 150, 153, 165, 167, 175, 188, 218, 239, 250, 290, 297 and 326.

adequate regulatory compliance by private companies having private interests, in particular on CB issues. In the present case, All Core NRAs referred decision-making on All Core TSOs' RDCTCS Proposal to ACER on the basis of Article 9(11) CACM: *"Where the regulatory authorities have not been able to reach agreement within the period referred to in paragraph 10, or upon their joint request, the Agency shall adopt a decision concerning the submitted proposals for terms and conditions or methodologies within six months, in accordance with Article 8(1) of Regulation (EC) No 713/2009."*

490. ACER carried out the regulatory supervision of All Core TSOs' RDCTCS Proposal under the CACM which had been referred to it by All NRAs in accordance with the CACM's referral procedure.
491. ACER did not bestow additional powers on itself beyond the powers conferred by the ACER Regulation. It exercised the powers that it was under an obligation to exercise in accordance with Article 9(11) of the CACM and Article 5(3) ACER Regulation and Article 6(10) of the ACER Regulation.
492. As set out above in Sub-Plea 3.2, given that All Core TSOs' RDCTCS Proposal did not contain a legitimate LF threshold as required by Article 16(13) ER, ACER had to ensure compliance with Article 74(6)(f) CACM and Article 16(13) ER.
493. Article 16(13) ER requires that the legitimate LF threshold *"shall be jointly analysed and defined by all transmission system operators in a capacity calculation region for each individual bidding zone border, and shall be subject to the approval of all regulatory authorities in the capacity calculation region"*.
494. ACER therefore asked All Core TSOs to set the legitimate LF threshold required by Article 16(13) ER in a 4 month deadline but, in the absence of compliance by All Core TSOs, it was under a duty to ensure compliance with Article 16(13) ER and therefore determined a temporary common threshold for legitimate LFs in the amount of 10%, following a rigorous analysis of the results from All Core TSOs' Experimentation Report, All Core TSOs' Non-Paper, All Core NRAs' Non-Paper and the results from ACER's own simulations using a variety of parameters. ACER Decision 30/2020's RDCTCS clarifies that this threshold is temporary and will automatically be replaced by a new threshold commonly determined by All Core TSOs and approved by All Core NRAs.
495. ACER duly exercised its powers in accordance with the principle of subsidiarity and proportionality. As was set out in Sub-Plea 3.7, a common threshold for legitimate LFs is not only necessary but suitable to attain the objectives of the applicable regulatory framework.
496. Given the indispensability of a LF threshold in order to create the RDCTCS as mandated by the CACM, and to also ensure compliance with the ER, in particular Article 16(13)ER, the ACER Decision 30/2020 had to contain a threshold for legitimate LFs.
497. In the absence of a threshold for legitimate LFs, ACER Decision 30/2020's RDCTCS could not have ensured compliance with the Article 74(6)(b) CACM, which requires the RDCTCS to *"be consistent with the responsibilities and liabilities of the TSOs involved"*. All Core TSOs had the responsibility to determine a threshold for legitimate LFs. The absence of an agreement forced ACER to determine a temporary LF threshold that would disappear as soon as All Core TSOs would determine a definitive LF threshold (which All Core TSOs could do prior to the implementation of the RDCTCS in order to avoid that ACER's temporary LF threshold be used at all).
498. In the absence of a threshold for legitimate LFs, ACER Decision 30/2020's RDCTCS could not have ensured compliance with Article 74(6)(e) CACM, requiring the RDCTCS to *"facilitate the efficient long-term development and operation of the pan-European interconnected system and the efficient operation of the pan-European electricity market"*. Both the efficient long-term development and operation of the EU interconnected system and the efficient operation of the EU electricity market require that the costs of RDCT actions be shared at a regional level among

TSOs through a cost sharing solution. And a legitimate LF threshold is indispensable in order to create a RDCTCS in line with the PPP, as mandated by the ER.

499. In the absence of a threshold for legitimate LFs, ACER Decision 30/2020's RDCTCS could not have ensured compliance with the Article 74(6)(f) CACM, which requires the RDCTCS to "facilitate adherence to the general principles of congestion management as set out in Article 16 ER". Article 16(13) ER expressly requires that a "level" is set below which structural congestion can be expected in a BZ. Given that All Core TSOs had not (yet) reached an agreement on the legitimate LF threshold, ACER was under a regulatory obligation to set a temporary LF threshold in order to ensure compliance with the CACM and the ER. The absence of the temporary LF threshold set by ACER would have thwarted the application of the PPP, at the heart of the cost sharing methodology of the RDCTCS. The PPP is at the heart of the cost sharing methodology of the RDCTCS⁸⁵.
500. The absence of the temporary LF threshold set by ACER would also have jeopardised the *effet utile* of Article 74 CACM, given that the threshold for legitimate LFs is as an indispensable part of the RDCTCS, as expressly recognised by ACER Decision 30/2020. Paragraph 109 of ACER Decision 30/2020 states: "*The threshold for loop flows is an indispensable part of the cost sharing methodology, because Article 16(13) of the Electricity Regulation establishes a principle by which loop flows, which are expected in bidding zones without structural congestions should not be considered as contributing to congestion and therefore penalised. This principle reflects the fundamental nature of zonal electricity market model that even in an optimal bidding zone configuration, some levels of loop flows would still persist and are therefore inherent in any zonal market model. Article 16(13) of the Electricity Regulation therefore establishes a rule by which this normal level of loop flows is legitimate and should not be penalised.*"
501. The need for such a threshold was acknowledged by All Core TSOs in Article 8 of All Core TSOs' RDCTCS Proposal. The Explanatory Document to All Core TSOs' RDCTCS Proposal⁸⁶ demonstrates that All Core TSOs unanimously agreed on a LF threshold in Section 4.5 and that the discussion merely related to the parameters of the threshold:
*"4.5.1 Treatment of loop flow.
Loop flows are unscheduled flows and make use of cross-border capacity (indirectly) prior to the Market Flows. For the prioritisation of the different flows identified by the flow decomposition methodology, burdening loop flows are seen as the most critical flows. In accordance with the ACER recommendation and to avoid free-riding of neighbouring countries, those flows should be penalised in the first place in case a XBRNE is overloaded¹⁵. Therefore loop flows are considered as polluters. They are also, individually, associated with only one bidding zone.
The electricity network of the Core CCR is highly meshed and in combination with the zonal design of the EU Internal Energy Market a certain level of loop flows is therefore inevitable, even with the most ambitious grid investments. Indeed, such a goal could lead to the target which could be opposite to the goals of internal electricity market (lower investments in cross-border lines). Due to these reasons a threshold for the loop flows could be considered. The consequence of applying a threshold is that a part of the loop flows gets accepted and gets less highly prioritised as the remaining bigger share. This option leads to the following questions:
On what parameter does the threshold apply?
(For the sake of clarity, please find an example in order to grasp the difference between the two possible options or parameters.)(..)"*
502. Similarly, All Core NRAs unanimously agreed on the need for a LF threshold in All Core NRAs' Non-Paper, Section 2.3⁸⁷. The debate was not on whether to have a threshold but what the scope of application of the threshold had to be: "*In short, all Core NRAs agree that the flows below the defined threshold should be borne by the TSO responsible for the area to which the congested network element belongs.*"

⁸⁵ See ACER Decision 30/2020, para 109.

⁸⁶ Annex 13 to the Defence, p. 45.

⁸⁷ ACER Decision 30/2020, para 23.

503. In their Non-Paper (Section 1.9, “*Loop Flow Threshold*”), all Core TSOs also unanimously agreed on the need for a LF threshold⁸⁸: “*In accordance with article 16(13) of REGULATION (EU) 2019/943, TSOs have to define the acceptable level of flows resulting from transactions internal to bidding zones. This level of acceptable loop flow is defined by a loop flow threshold.*”. The debate was centred on the modalities of such threshold.
504. In the absence of ACER’s determination of a temporary threshold for legitimate LFs, a deadlock situation could have occurred whereby the inability for All Core TSOs to reach an agreement could have led to the consequence that no adequate RDCTCS could have been implemented.
505. ACER had two options when it faced a lack of compliance of All Core TSOs’ RDCTCS Proposal with the requirements of Article 16(3) ER: either to specify a legitimate LF threshold itself or instead to require All Core TSOs propose to specify a legitimate LF threshold. ACER chose the latter, in line with the principle of proportionality, and asked All Core TSOs to specify a legitimate LF threshold within a 4-month deadline, which was reasonable to enable ACER to subsequently supervise its compliance with the applicable regulatory framework and approve it. However, in the absence of an agreement between All Core TSOs, ACER was under a duty to ensure that the RDCTCS complied with the applicable regulatory framework, including Article 16(13) ER and contained a legitimate LF threshold. It therefore determined a temporary common threshold for acceptable LFs in the amount of 10%, following a rigorous analysis of the results from All Core TSOs’ Experimentation Report, All Core TSOs’ Non-Paper, All Core NRAs’ Non-Paper and the results from ACER’s own simulations using a variety of parameters. ACER Decision 30/2020’s RDCTCS clarifies that this threshold is temporary and will automatically be replaced by a new threshold commonly determined by All Core TSOs and approved by All Core NRAs. ACER Decision 30/2020’s RDCTCS does not set any time restrictions upon Core TSOs and NRAs to adopt a definitive legitimate LF threshold replacing the temporary threshold of ACER Decision 30/2020’s RDCTCS. This implies that All Core TSOs and NRAs could adopt a definitive legitimate LF threshold before the actual implementation of the RDCTCS and avoid the implementation of the temporary threshold all in all.
506. In other terms, ACER left it up to All Core TSOs to determine the legitimate LF threshold but, in the absence of such timely determination, ensured an interim solution in order not to jeopardise the implementation of the RDCTCS and, what is more, the implementation of the interim solution could still be avoided by All Core TSOs as soon as they would agree on a definitive legitimate LF threshold to replace ACER’s temporary threshold. All Core TSOs’ could even agree to determine a legitimate LF threshold before the implementation of the RDCTCS in order to avoid any use of ACER’s temporary threshold at all.
507. The Board of Appeal refers by analogy to similar Case A-008-2020 relating to the Imbalance Netting Implementation Framework (INIF)⁸⁹, where, given the lack of compliance of All TSOs’ 4th INIF Proposal with the requirement to either clearly state whether it proposed to designate, on the one hand, the same entity as the Imbalance Netting Process Function (INPF)/TSO-TSO Settlement Function (TTSF) entity for the Capacity Management Function (CMF) entity or, on the other hand, a different CMF entity, ensuring and demonstrating compliance with the additional requirements of Article 22(3)(e) of Regulation (EU) 2017/2195 (EBGL), ACER inserted the obligation upon All TSOs to designate a CMF entity within a reasonable period of 2 and a half years, leaving it up to the TSOs to decide whether this entity would be identical to the INPF/TTSF entity or different from the INPF/TTSF entity, as long

⁸⁸ ACER Decision 30/2020, para 25.

⁸⁹ Board of Appeal Decision A-008-2020, paras 229, 276 and 300.

as compliance with the additional requirements of Article 22(3)(e) of the EBGL was ensured and demonstrated if multiple entities were designated. In so doing, the Agency refrained from either setting additional conditions to bring All TSOs' 4th INIF Proposal in line with Article 22(3)(e) of the EBGL as regards the CMF or from designating the CMF entity itself. Instead, it allowed the TSOs to arrive at a solution they deemed most adequate, within the confines of the legal requirements, without adding any further conditions as to the entity to operate the CMF function.

508. In a similar way as in A-008-2020⁹⁰, ACER Decision 30/2020 could not remain silent on the issue because such silence would have been contrary to the applicable regulatory framework.

3.10 The LF threshold infringes the duty to reason.

509. Appellant I⁹¹ claims that the common threshold for acceptable LFs is not properly reasoned as regards the need for a higher LF threshold for larger BZs with larger amounts of electricity generation from renewable energies.

510. The Board of Appeal refers to Sub-Plea 1.13 above, which lists the legal provisions compelling ACER to comply with the duty to reason.

511. Section 6.2.2.5 of ACER Decision 30/2020, entitled "*The threshold for legitimate level of LFs*" (paragraphs 107 until 122), contains ACER's clear and unequivocal reasoning of its decision to set a temporary LF threshold, covering 4 full pages of the decision. ACER Decision 30/2020 dedicates an entire paragraph to the concerns of some Core TSOs and NRAs from large BZ (paragraph 118):

"(118) Some Core TSOs and regulatory authorities from large bidding zones also argued that equal splitting of the common threshold among all bidding zones is discriminatory towards larger bidding zones and instead a proportional splitting should be applied. ACER rejected such a proposal, because a proportional splitting of a threshold would make the concept of a loop flow threshold (as defined Article 16(13) of the Electricity Regulation) void, since the proportional splitting does not ensure that bidding zones which create very small loop flows and are considered as without structural congestion do not pay any costs. This is evident from the examples provided in Tables 1 and 2 below. In Table 1, equal splitting of the 10% common threshold to five bidding zones would result in an individual threshold equal to 2%. However, since bidding zone 1 does not use the whole individual threshold, the individual threshold can be increased by 2.33%, which results in exactly 10% of total sum of the loop flows below the individual threshold. In Table 1, the equal splitting of the common threshold ensures that bidding zones, which create small loop flows and are therefore considered as being without structural congestion, do not pay anything."

512. Taking account of the fact that the addressees of ACER Decision 30/2020 are TSOs, which are sufficiently acquainted with the technicalities of the RDCTCS and in the light of the extensive consultations and hearing process on the threshold for acceptable LFs (see Sub-Plea 3.2), ACER Decision 30/2020's reasoning is adequate in relation to the determination of the common threshold for acceptable LFs. ACER reasoned that individual thresholds per BZ, based on a common LF threshold of 10%, was a necessary and appropriate temporary solution until Core TSOs would define and Core NRAs would approve the level of a more appropriate LF threshold in accordance with Article 16(13) ER. Even though it is impossible for ACER to fully reproduce the detailed technical analyses that led to the methodological choices adopted in ACER Decision 30/2020, it transpires from the clear and unequivocal reasoning underpinning its methodological choice for a common threshold for legitimate LFs that such analysis took place at an earlier stage in the proceedings.

513. Appellant I's claim with regards to the temporary LF threshold is detailed and demonstrates that the Appellant clearly and unequivocally understood the underlying reasoning of ACER Decision 30/2020 on the temporary legitimate LF threshold. The pleas of Appellant I reiterate

⁹⁰ Board of Appeal Decision A-008-2020, paras 188, 293 and 297.

⁹¹ Appeal I, Plea 2, para 153.

the arguments that it tabled throughout the proceedings leading-up to ACER Decision 30/2020. The appeal expresses the Appellant's dissatisfaction with the duly stated reasons set out in paragraphs 107-122 of ACER Decision 30/2020. This evidences that ACER provided the Appellant with a clear and unequivocal reasoning, which it was able to understand and is now able to rebut, even though it is dissatisfied with its contents.

514. The Board of Appeal concludes that the Agency did not fail to adequately state reasons in ACER Decision 30/2020.

515. **It follows that the Third Consolidated Plea must be dismissed as unfounded.**

Fourth Consolidated Plea – Unlawful transfer of responsibilities from TSOs to RCCs.

516. Appellant II⁹² claims that Article 35(5) ER and Article 40(1)(d) Electricity Directive establish a hierarchy of primary responsibility for (i) managing electricity flows and (ii) ensuring the security, reliability and efficiency of the electricity system (“**secure system operation**” or “**SSO**”). Appellant II claims that this hierarchy establishes that the SSO responsibility lies with the individual TSOs in relation to power systems that they operate. Appellant II alleges that the role of the Regional Coordination Centres (“**RCCs**”) is complementary to the basic tasks of TSOs and limited to actions of regional relevance.

517. Appellant II alleges that Article 9(2) of Contested Decision's ROSC transfers all measures available for Core TSOs' SSO responsibility from Core TSOs to RCCs. In so doing, Core TSOs are prevented from taking measures to operate their electricity systems in a secure manner and from meeting their responsibilities. This is because, in Appellant II's view, Article 9(2) of the Contested Decision's ROSC (i) considers that all RAs at transmission level are by default XRAs and (ii) mandates all RAs at transmission level in every network and balancing situation to be exclusively activated by the CROSA.

518. ACER responds in its Defence⁹³ that Article 9(2) of the Contested Decision's ROSC does not define all RAs at transmission level by default as having cross-border relevance (XRAs). It refers to the test for XRAs of Article 9(1) of the Contested Decision's ROSC. In its opinion, the division of responsibilities between TSOs and RSCs/RCCs under the Contested Decision is lawful and complies with all legal provisions allegedly violated according to Appellant II.

519. Article 35(5) ER states: “*Regional coordination centres shall complement the role of transmission system operators by performing the tasks of regional relevance assigned to them in accordance with Article 37. Transmission system operators shall be responsible for managing electricity flows and ensuring a secure, reliable and efficient electricity system in accordance with point (d) of Article 40(1) of Directive (EU) 2019/944.*”

520. Article 40(1)(d) Electricity Directive states: “*Each transmission system operator shall be responsible for (...) (d) managing electricity flows on the system, taking into account exchanges with other interconnected systems. To that end, the transmission system operator shall be responsible for ensuring a secure, reliable and efficient electricity system and, in that context, for ensuring the availability of all necessary ancillary services, including those provided by demand response and energy storage facilities, insofar as such availability is independent from any other transmission systems with which its system is interconnected*”.

521. Article 9(2) of the Contested Decision's ROSC reads as follows: “*All potential RAs identified pursuant to paragraph 1 shall be considered as cross-border relevant (XRAs), unless all Core TSOs unanimously agree that a potential RA is not cross-border relevant.*”

522. Article 9(2) of the Contested Decision's ROSC refers to Article 9(1) of the Contested Decision's ROSC, which reads as follows: “*Within one month after the list of XNEs has been defined in accordance with Article 7, Core TSOs shall share with the Core RSC(s) all potential RAs, designed in accordance with CSAM, which are at least sometimes able to address violations of current limits on XNEs. In doing so, each Core TSO shall also consider the potential RAs recommended by Core RSC(s) in accordance with*

⁹² Appeal II, Plea 1, paras 22-25.

⁹³ Defence, paras 242-253.

Article 78(2)(a) of the SO Regulation. Each Core TSO shall continuously assess the possibility for new potential RAs. All Core TSOs and RSC(s) shall commonly assess the possibility for new potential RAs at least on biannual basis.

4.1 The creation of RSCs and RCCs.

523. Regional cooperation of electricity system operation was initiated by the transmission system operators ('TSOs') and the national regulatory authorities ('NRAs') through voluntary regional initiatives in the 1950's⁹⁴. These regional initiatives developed into the creation of voluntary Regional Security Coordinators ("RSCs")⁹⁵. RSCs constitute "a first step towards further regional coordination and integration of system operation" as per Recital (6) SO⁹⁶. RSCs are owned and appointed by TSOs. Their 6 functions are to make non-binding recommendations limited to (i) coordinated security analysis, (ii) coordinated capacity calculation, (iii) outage coordination, (iv) short-term and medium-term adequacy forecasts, (v) consistency assessment of system restoration plans and (vi) common grid model building.
524. The regional coordination of electricity system operation foreseen by the ER is a gradual, bottom-up process, in which, at different points in time, various stakeholders - in essence ENTSO-E, the TSOs, the NRAs and the Agency - are required to take formal steps to attain certain milestones set by the ER⁹⁷.
525. RCCs have been created to enhance regional cooperation, in accordance with Article 35(2) ER. They will replace RSCs as of 1 July 2022. The creation of RCCs is part of Chapter V ER, which introduces a framework of enhanced regional coordination of electricity SO throughout the EU.
526. Recital (53) ER sets out the *raison d'être* of the RCCs: "Coordination between transmission system operators at regional level has been formalised with the mandatory participation of transmission system operators in regional security coordinators. The regional coordination of transmission system operators should be further developed with an enhanced institutional framework via the establishment of regional coordination centres. The establishment of regional coordination centres should take into account existing or planned regional coordination initiatives and should support the increasingly integrated operation of electricity systems across the Union, thereby ensuring their efficient and secure performance. For that reason, it is necessary to ensure that the coordination of transmission system operators through regional coordination centres takes place across the Union. Where transmission system operators of a given region are not yet coordinated by an existing or a planned regional coordination centre, the transmission system operators in that region should establish or designate a regional coordination centre".
527. RCCs are independent and impartial legal entities (Articles 35(3) and (4) and 45 ER) under regulatory oversight of both NRAs and ACER (Articles 61 and 62 Electricity Directive and Article 46(2),(3) and (4) ER). According to Article 37 ER, RCCs will perform 10 additional functions on top of the 6 functions of the RSCs⁹⁸. Article 42 ER establishes that 14 functions will be limited to issuing non-binding recommendations - in a similar fashion to the former RSCs - but two of them, namely coordinated security analysis and coordinated capacity calculation, will amount to coordinated actions that are binding upon the TSOs. Recital (57) ER states, in this regard, that RCCs "should primarily act in the interest of system and market operation of the region. Hence, regional coordination centres should be entrusted with the powers necessary to coordinate

⁹⁴ Association of the Transmission System Operators of Ireland (ATSOI), Baltic Transmission System Operators (BALTSO), European Transmission System Operators (ETSO), NORDEL, Union for the Coordination of the Transmission of Electricity (UCTE) and UK Transmission System Operators Association (UKTSOA).

⁹⁵ The first RSCs saw the light in 2008. Subsequently, SO and Regulation (EU) 2017/2196 establishing a network code on electricity emergency and restoration proceeded to the regulation of these RSCs. Participation of TSOs in RSCs was made mandatory in 2016. The ER consolidated this regional, bottom-up process in 2019.

⁹⁶ See Board of Appeal Decision A-007-2020, paras 5-13.

⁹⁷ See Board of Appeal Decision A-007-2020, para 5.

⁹⁸ See Board of Appeal Decision A-007-2020, paras 5-13.

the actions to be taken by transmission system operators of the system operation region for certain functions and with an enhanced advisory role for the remaining functions.”

528. Whereas the geographical scope of the RSCs corresponds with one or more CCRs⁹⁹ and their number is limited to a maximum of six¹⁰⁰, the ER does not limit the amount of RCCs and provides them with a geographical scope of their own: the System Operation Regions (“SORs”)¹⁰¹ in accordance with Article 36 ER. RCCs perform their functions in a SOR.

4.2 The ROSC applies to XRAs.

4.2.1 The test is set by Article 9(1) of the Contested Decision’s ROSC.

529. The definition of XRAs is to be found in Article 9(1) of the Contested Decision’s ROSC. Article 9(1) of the Contested Decision’s ROSC contains the definition of XRAs.

530. Article 9(2) of the Contested Decision’s ROSC does not contain the definition of XRAs. Article 9(2) of the Contested Decision’s ROSC contains an exception to that definition.

531. Article 9(2) of the Contested Decision’s ROSC adds the possibility of an exception to the rule of Article 9(1) of the Contested Decision’s ROSC: an exception can be made if Core TSOs unanimously agree. As set out in the Contested Decision’s ROSC, the rule of Article 9(1) applies “*unless all Core TSOs unanimously agree that a potential RA is not cross-border relevant*”.

532. Article 9(2) of the Contested Decision’s ROSC further requests TSOs to consider potential RAs recommended by RSCs (predecessors of RCCs) in accordance with Article 78(2)(a) SO and to continuously assess the possibility for new potential RAs.

4.2.2 The test: XRAs on XNEs.

533. The rule of Article 9(1) of the Contested Decision’s ROSC is that TSOs share with RSCs all potential RAs, designed in accordance with CSAM, which are at least sometimes able to address violations of current limits on XNEs.

534. The test neither catches all RAs by default nor catches all NEs by default.

4.2.2.1 The concept of XNEs.

535. The rule of Article 9(1) of the Contested Decision’s ROSC is that TSOs share with RSCs all potential RAs, designed in accordance with CSAM, which are at least sometimes able to address violations of current limits on XNEs. The rule is clearly tied to the definition of “CB relevance” provided by the CSAM.

536. The test does not catch all NEs by default.

537. As set out above in Sub-plea 1.1.6 of the First Consolidated Plea, Article 15 of ACER Decision 07/2019 containing the EU-wide CROSA methodology adopted under Article 75 SO (“CSAM”¹⁰²), entitled “*Identification of cross-border relevant network elements and remedial actions*”, states that the CROSA applies to “cross-border relevant NEs” or XNEs.

538. It defines these XNEs as “*CNEs and other NEs above a voltage level defined by TSOs, except for those elements for which all TSOs in a CCR agree that they are not cross-border relevant*”

⁹⁹ Currently, there are 10 CCRs: (1) Baltic, (2) Channel, (3) Core, (4) Greece Italy (GRIT), (5) Hansa, (6) Italy North, (7) Ireland and United Kingdom (IU), (8) Nordic, (9) South East Europe (SEE) and (10) South West Europe (SWE).

¹⁰⁰ Article 77(2)(b) of the SO GL limits their number to six. The six RSCs are CORESO (2008), TSCNET (2008), SCC (2015), Nordic RSC (2016), Baltic RSC (2016) and SEleNE-CC (2020).

¹⁰¹ See Board of Appeal Decision A-007-2020, paras 13-15.

¹⁰² <https://eepublicdownloads.entsoe.eu/clean-documents/Network%20codes%20documents/Implementation/ccr/methodologies/core/cacm-deliverables/coordinated-rd-and-ct-art-35/20190117-core-report-harmonization-cacm-353-nrasfinal.pdf>

for the concerned CCR and may therefore be excluded”. As set out in paragraph 70 of ACER Decision 07/2019 on the CSAM, some NEs that are not CNEs may still be XNEs, for example when they are significantly impacted by LFs from neighbouring BZs. It states: “*To address this problem, the Agency is of the opinion that the notion of cross-border relevance should **include all network elements where the percentage of flows resulting from exchanges outside the TSO control area where such network element is located is significant**. As such, this principle requires deeper analyses by TSOs in a CCR. Therefore, the Agency replaced the proposed principle (i.e. at least critical network elements) with a more comprehensive high level principle to harmonise the identification of cross-border relevant network elements across CCRs. The latter should result in the cross-border relevant network elements to **comprise all network elements above certain voltage level except those network elements for which all TSOs in a CCR agree that they are not cross-border relevant**. The Agency also understands that including too many network elements in the coordination does not risk a loss of economic efficiency or operational security in regional coordination. However, including not enough network elements would indeed entail such risk. For this reason, the principle for the identification of cross-border relevant network elements as proposed by the Agency is considered as adequate.*” (emphasis added)

539. The CSAM applies since 2020. Following the CSAM decision at EU level, which established that RAs have to be coordinated, the CACM mandates a bottom-up decision-making process for the ROSC, RDCT and RDCTCS at Core CCR level. These processes have been finalised by ACER in the Contested Decision, Decision 35/2020 (RDCT) and Decision 30/2020 (RDCTCS).

540. Thus, at Core level, both the ROSC and the RDCT apply the CROSA to XNEs as defined by CSAM, i.e. (i) CNEs and (ii) NEs over a voltage level to be determined by All Core TSOs. All Core TSOs determined said voltage level at 220 kV. The scope implies that XNEs can be cross-border NEs or internal NEs, as long as they are cross-border relevant.

541. This has been graphically presented in the First Consolidated Plea as follows:

XNEs =

Includes: • **all CNEs (CCM)** (according to a yearly list of CNEs):

- all CZ NEs
- all internal NEs, defined by All Core TSOs, with a BZ-to-BZ PTDF $\geq 5\%$

• **other NEs ≥ 220 kV**

Excludes: XNEs that are not CNEs, i.e.:

- radial lines, distribution NEs, transformers with secondary voltage < 220 kV
- other NEs as commonly agreed upon by All Core TSOs
- XNEs that are part of another CCR CROSA (for TSOs belonging to more than one CCR)

Source: Board of Appeal.

542. As set out in the First Consolidated Plea, when setting the limit of 220 KV, ACER duly reproduced Article 5(1) of All Core TSOs’ ROSC Proposal, in which All Core TSOs stated that “*network elements in the Core CCR with a voltage level higher or equal to 220 kV*” would be “*subject to CROSA, on which operational security limits violations need to be managed in a coordinated way*”¹⁰³.

543. The Explanatory Document to All Core TSOs’ ROSC Proposal¹⁰⁴ refers to the CSAM for the definition of XNEs: “*3.3 Cross-border relevance of remedial actions. The CSA methodology defines a cross-border remedial action (XRA) as a RA identified as cross-border relevant and which needs to be applied in a coordinated way. The cross-border relevance of a RA shall be evaluated qualitatively or quantitatively for at least each cross-border relevant network element and each contingency.*”

¹⁰³ https://eepublicdownloads.entsoe.eu/clean-documents/nc-tasks/EBGL/SO_GL_A76_CORE_CCR_ROSC%20Methodology.pdf

¹⁰⁴ Annex 22 to the Defence, p. 11. All Core TSOs’ ROSC Proposal differentiated between secured NEs and scanned NEs. The terminology “secured NEs” corresponds with XNEs. Scanned NEs are NEs monitored during CROSA such that CROSA does not worsen, or create new OS violations (see Article 2(s) of the Contested Decision’s ROSC

544. It clearly delineates the scope for XNEs as follows¹⁰⁵:

*“The following figure 2 shows **which elements (highlighted in yellow)** can be discarded from the set of secured elements in accordance with the provisions explained above:*

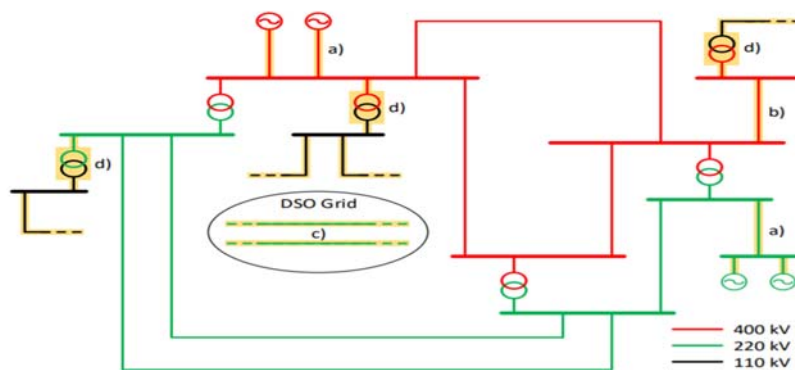
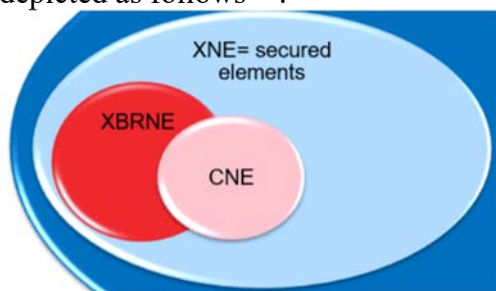

Figure 2: Elements (highlighted in yellow) which can be discarded from the set of Core XNEs

*In addition to these criteria, **any element can be discarded from the set of secured elements, when a common agreement among Core TSOs is reached.** This could be the case, if a part of the grid is almost not influenced trans-regionally. However, such a rule cannot be applied to the Critical Network Elements in accordance with Article 5 of day-ahead and intraday capacity calculation methodology of the Core CCR and XBRNEs in accordance with the Core RD and CT methodology.”*

Source: Explanatory Document to All Core TSOs’ ROSC Proposal of 19 December 2019 (emphasis added)

545. The Explanatory Document expressly adds that the definition of Core XNEs may include NEs in the same control area, i.e. internal NEs: *“Considering the definition of Core XNEs, it is obvious that some RAs will only have a relevant impact on XNEs located in the same control area and will de facto only affect its connecting TSO. Nevertheless, these remedial actions will still be named “cross-border relevant” and flagged as XRAs.”* The fact that the scope of XNEs would be wider than CNEs was graphically depicted as follows¹⁰⁶:



Source: Explanatory Document to All Core TSOs’ ROSC Proposal.

546. Appellant II claims, with respect to the exceptions, that Core TSOs would not have an incentive to agree on exceptions to exclude XNEs from regional coordination. Appellant II alleges that this is especially true for RD actions, which always have an impact to some extent on all NEs in the whole interconnection and that, when there is not enough RD potential available close to the congested NE, even quite remote NEs are used to relieve congestion. It refers to multilateral RAs of the voluntary Multilateral Remedial Action Agreement (“**MRA Agreement**”) aimed at ensuring network security between 14 (Core and non-Core) TSOs under the umbrella of RSC TSCNET GmbH¹⁰⁷ following regulatory approval. Appellant II reiterated at the Oral Hearing that an agreement by Core TSOs on the exceptions is not guaranteed at all.

¹⁰⁵ Annex 22 to the Defence, p. 9.

¹⁰⁶ Annex 22 to the Defence, p. 10.

¹⁰⁷ <https://www.tscnet.eu/>.

547. As set out in the First Consolidated Plea, regional RA coordination can only occur if an adequate cost sharing ensues and, *vice versa*, cost sharing of RAs can only occur once the RAs have taken place. Hence, when a Core TSO proposes an exception to exclude XNEs from regional coordination, other Core TSOs are not expected to object to this exclusion because it is in their interest not to pay the costs for XRAs on those XNEs as per the RDCTCS of ACER Decision 30/2020.
548. The Board of Appeal observes, in addition, that the overall benefits provided by regional OS coordination – e.g. an increased activation of less costly RAs – strikes a correct balance between the rule and the exception. It avoids free-riding attempts by TSOs to exclude NEs they own in order to unilaterally decide upon RAs and to include NEs owned by neighbouring TSOs in order to relieve congestions inside their grid.
549. The MRA Agreement has not been adopted by All Core TSOs and is neither covered by Article 76(1)(b)(v) SO nor by Core ROSC. The reference by Appellant II to an increased need for multilateral RAs according to the MRA Agreement underlines a need for regional coordination in order to enhance OS and an efficient relief of congestions.
550. Finally, the Board of Appeal refers to Sub-plea 1.1.7 of the First Coordinated Plea with respect to the alleged infringement of Article 76(2) SO.
551. Article 76(2) SO requires that, in determining whether congestion has CB relevance, TSOs take into account the congestion that would appear in the absence of energy exchanges between control areas. First, as expressly set out in paragraph 133 of ACER Decision 33/2020 (ROSC), the threshold of ≥ 220 kV was set in accordance with the PPP articulated in Article 76 SO and took account of the structural congestion that would appear in the absence of energy exchanges. This threshold implies that, in the absence of energy exchanges, NEs ≥ 220 kV would not be congested and are thus XNEs. Second, Article 76(2) SO refers to the absence of energy exchanges between control areas. This means that there is no explicit prohibition for other congestions to be taken into account. If the congestion that would appear in the absence of energy exchanges between control areas (i.e. between BZs) would be the only factor to distinguish between cross-border congestions and non-cross-border relevant congestions, then the congestion caused by LFs (due to energy exchanges within BZs) would not be considered as cross-border relevant. This would contradict the PPP of Article 16(13) ER.

4.2.2.2 The concept of XRAs.

552. The rule of Article 9(1) of the Contested Decision’s ROSC is that TSOs share with RSCs all potential RAs, designed in accordance with CSAM, which are at least sometimes able to address violations of current limits on XNEs. The rule is clearly tied to the definition of “CB relevance” provided by the CSAM, as shown in the following figure:

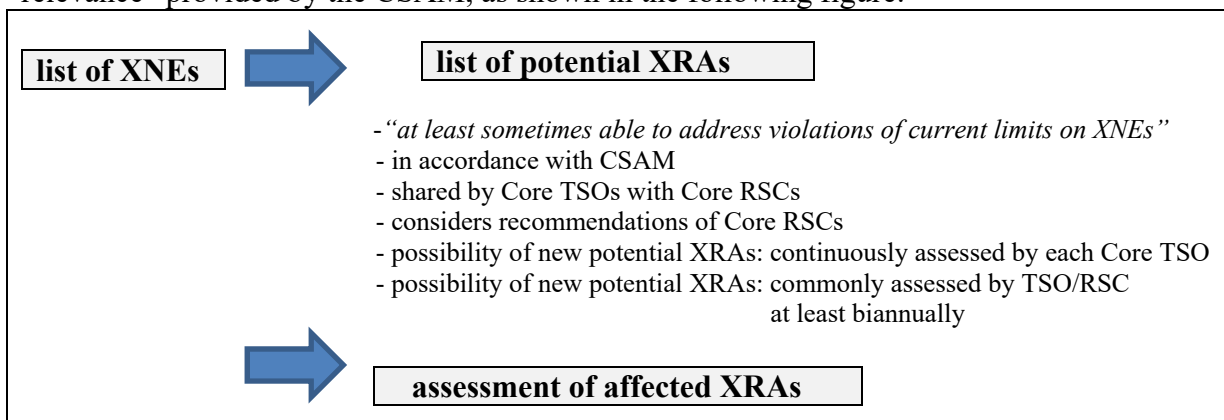

- | |
|--|
| <ul style="list-style-type: none">- jointly assessed by Core TSOs in coordination with Core RSCs- qualitative/quantitative approach |
|--|

Source: Board of Appeal

553. The test does not catch all RAs by default.
554. The test is that potential RAs include RAs that are at least able to address violations of current limits on XNEs. Article 2(a) of the Contested Decision's ROSC defines a XRA as "a remedial action identified as cross-border relevant and needs to be applied in a coordinated way". If RAs are unable to address violations of current limits on a XNE, such RAs cannot qualify as XRAs.
555. The delimitation is clear-cut: (i) only XRAs able to address violations of current limits on XNEs can fall within the scope of the Contested Decision's ROSC and, hence, imply an involvement of RSCs when performing the CROSA; and (ii) non-XRAs are unable to address violations of current limits on non-XNEs, fall foul of the Contested Decision's ROSC and are activated unilaterally by TSOs, regardless of CROSA.
556. The delineation between the responsibilities of TSOs and RSCs in the Contested Decision's ROSC duly complies with the applicable regulatory framework. Indeed, it reflects the requirements of Article 21(1)SO, entitled "*Principles and criteria applicable to remedial actions*".
557. Article 21(1)(a) SO, on the one hand, defines the non-XRAs for which TSOs retain responsibility: "*each TSO shall apply the following principles when activating and coordinating remedial actions in accordance with Article 23: (a) for operational security violations which do not need to be managed in a coordinated way, a TSO shall design, prepare and activate remedial actions to restore the system to the normal state and to prevent the propagation of the alert or emergency state outside of the TSO's control area from the categories defined in Article 22*".
558. Article 21(1)(b) SO, on the other hand, defines the XRAs, which shall be subject to regional coordination by RSCs: "*each TSO shall apply the following principles when activating and coordinating remedial actions in accordance with Article 23: (...) (b) for operational security violations which need to be managed in a coordinated way, a TSO shall design, prepare and activate remedial actions in coordination with other concerned TSOs, following the methodology for the preparation of remedial actions in a coordinated way under Article 76(1)(b) and taking into account the recommendation of a regional security coordinator in accordance with Article 78(4)*." XRAs cannot be unilaterally activated by TSOs, as this would negatively affect regional coordination. This is also confirmed by Article 35(4) CACM, which states, regarding RDCTs, that "*Each TSO shall abstain from unilateral or uncoordinated redispatching and countertrading measures of cross-border relevance. Each TSO shall coordinate the use of redispatching and countertrading resources taking into account their impact on operational security and economic efficiency*."
559. In setting the test to define XRAs, the Contested Decision is consistent with All Core TSOs' ROSC Proposal¹⁰⁸ which states in its Article 10(2) that Core TSOs shall jointly assess, in coordination with Core RSCs the cross-border relevance of potential RAs shared by Core TSOs in accordance with Article 10(1). Article 10(1) of All Core TSOs' ROSC Proposal required Core TSOs to share, within one month of the definitive list of secured NEs (which corresponds with XNEs, as set out above in Sub-plea 4.2.2.1), "*all potential RAs, designed in accordance with article 14 of CSAM, which are at least generally able to address violations of current limits*".
560. ACER explains in its Defence and Rejoinder that the rationale for the definition of XRAs in the Contested Decision's ROSC is that, in the meshed environment of Core CCR, it is not possible to use a simplistic concept of XRAs as "RAs on XNEs" and non-XRAs as "RAs on non-XNEs". This is because XNEs are significantly impacted by nearby XRAs and XRAs

¹⁰⁸ https://eepublicdownloads.entsoe.eu/clean-documents/nc-tasks/EBGL/SO_GL_A76_CORE_CCR_ROSC%20Methodology.pdf

significantly impact nearby XNEs¹⁰⁹. The Board of Appeal observes, in this regard, that this is the reason why RSCs perform their functions at CCR level and RCCs at SOR level (see above, Sub-Plea 4.1).

561. As clearly set out in the Contested Decision's ROSC, when both XRAs and non-XRAs are concerned, the ROSC refers to "**(X)RAs**". Article 2(4)(a) of the Contested Decision's ROSC states that "*In this ROSC Methodology, unless the context requires otherwise: (a) The acronym '(X)RA' is used where the reference can mean both the remedial action or cross-border relevant remedial action*". To address Appellant II's concerns in its Reply, a correct application of the term (X)RA confirms that Article 14(3) of the Contested Decision's ROSC grants individual SSO responsibility to Core TSOs for certain RAs¹¹⁰.
562. Appellant II claims that the relevance of the distinction XRAs/non-XRAs is contradicted by the fact that the security assessment of the Contested Decision's ROSC does not contain a first, local "non-CB congestion relief"-stage within each BZ by the local Core TSO and a subsequent regional "CB congestion relief" by Core RSCs in cooperation with relevant Core TSO(s), especially since a same generator can be used for RD actions classified as XRAs or non-XRAs. Article 14 of the Contested Decision's ROSC does not provide a sequential but an integrated execution of the security assessment: Core TSOs include RAs before the DA CROSA (with a possibility of a 2 runs, a non-binding and binding run).
563. First, the issue as to whether the Contested Decision's ROSC is correct in providing an integrated process as opposed to a sequential process is irrelevant to Appellant I's claim on the correct differentiation between XRAs and non-XRAs. Both an integrated process and a sequential process require a correct differentiation between XRAs and non-XRAs to enable due regional coordination of RAs on XNEs in Core CCR.
564. Second, Article 78 SO requires an integrated process, whereby TSOs provide RSCs with necessary inputs but "*each regional security coordinator shall (a) perform the coordinated regional operational security assessment in accordance with Article 76 SO(.) and "coordinate the preparation of remedial actions with and among TSOs in accordance with Article 76(1)(b), to enable TSOs achieve a coordinated activation of remedial actions in real-time (.)"*". The sequential process is only after the RSC has issued its recommendation. Then, according to Article 78(4) SO, TSOs "*shall evaluate the recommended remedial action for the elements involved in that remedial action and located in its control area*" and "*decide whether to implement the recommended remedial action*".
565. Third, a sequential security assessment (a prior local assessment per BZ followed by a regional assessment) would hinder an efficient regional coordination because it would be burdensome, time-consuming (not allowing for a frequent re-calculation of CZCs), costly (2 processes instead of 1) and inefficient (2 processes activating the same RAs potentially cancelling each other out, e.g. upward activation of RAs followed by downward activation of the same RA).
566. In light of the above, the Board of Appeal concludes that the responsibilities of Core TSOs and Core RSCs (Core RCCs' predecessors) have clearly been delineated in the Contested

¹⁰⁹ Rejoinder, para 12: "*If one starts by defining a network element on the German-Polish border as cross-border relevant, this implies that some RAs within a distance of a few hundred kilometres need to be XRAs, and this further implies that an XRA located centrally in Poland will significantly impact network elements which are far from the German-Polish border. In Continental Europe, this chaining of influence stops only at the perimeter of synchronous areas connected via HDVC interconnectors.*"

¹¹⁰ Article 14(3) of the Contested Decision's ROSC, related to "*Preparation and updates of IGMs by Core TSOs*", states: "*In accordance with CSAM, each Core TSO shall have the right to include in its IGM, the (X)RAs for which this TSO is the only XRA affected TSO and that are resulting from the local preliminary assessment performed by such Core TSO at any time.*"

Decision's ROSC in compliance with Articles 35(5) ER and 40(1)(d) Electricity Directive. There is no unlawful transfer of SSO responsibilities from Core TSOs to Core RSCs/RCCs. All Core TSOs retain all SSO responsibilities regarding non-XRAs, which require neither regional coordination nor any involvement of RSCs/RCCs, in accordance with Article 21(1)(a) SO.

4.2.3 Coordination requires the involvement of RSCs/RCCs.

567. Appellant II erroneously considers that regional coordination implies a shift of responsibilities from TSOs to RSCs/RCCs.
568. As set out above in Sub-plea 4.2.2.2, the responsibilities of Core TSOs and Core RSCs have clearly been delineated in the Contested Decision's ROSC in compliance with Articles 35(5) ER and 40(1)(d) Electricity Directive. There is no unlawful transfer of SSO responsibilities from Core TSOs to Core RSCs/RCCs. All Core TSOs retain all SSO responsibilities regarding non-XRAs, which require neither regional coordination nor any involvement of RSCs/RCCs, in accordance with Article 21(1)(a) SO.
569. Both when setting the rule to determine XRAs and when setting the exception to the rule, the Contested Decision's ROSC foresees cooperation between Core TSOs and RSCs. Article 9(2) of the Contested Decision's ROSC foresees that *"All Core TSOs and RSC(s) shall commonly assess the possibility for new potential RAs at least on biannual basis.* Article 9(3) of the Contested Decision's ROSC foresees that *"Core TSOs, in coordination with Core RSC(s), shall jointly assess the XRA affected TSOs for each XRA determined pursuant to paragraph 2."* This is shown above in the figure of Sub-plea 4.2.2.2.
570. Moreover, even in relation to XRAs, Core RSCs' functions complement Core TSOs' functions with respect to their SSO responsibilities. Regional coordination adds a requirement upon TSOs to involve RSCs when carrying out their responsibilities but does not shift their responsibilities to RSCs. The Board of Appeal notes that Core TSOs play a key role in that coordination and in the CROSA process. Core TSOs provide the inputs to the CROSA (Article 13(1) of the Contested Decision's ROSC). Core TSOs optimise XRAs together with Core RSCs (Article 20(1) of the Contested Decision's ROSC). Core TSOs retain the right to accept or to reject the recommended XRAs as a result of the CROSA (Article 27(2) of the Contested Decision's ROSC). Core TSOs bear the final responsibility regarding the activation of XRAs (Article 31(1) of the Contested Decision's ROSC). At the Oral Hearing, ACER emphasised TSOs' key role in the ROSC.
571. Article 27(1) of the Contested Decision's ROSC sets out that Core RSCs recommend XRAs: *"Core RSC(s) shall recommend the implementation of the most effective and economically efficient XRAs identified by the RAO to the XRA connecting TSOs and inform at least all XRA affected TSOs about this recommendation."*
572. Article 27(2) of the Contested Decision's ROSC stipulates that Core TSOs retain the right to accept or reject the XRAs recommended by Core RSCs: *"In accordance with CSAM, Article 78(4) of the SO Regulation and Article 42(2) of the Electricity Regulation, during each CROSA, the recommended XRAs shall be considered as agreed, except where it is rejected by: (a) any XRA affected TSO (including XRA connecting TSOs) on the grounds that the implementation of a specific XRA would result in operational security violations; (b) XRA connecting TSO on the grounds that the recommended XRA is no longer available."*
573. Regarding Appellant II's concerns on the tight timing in relation to the possibility to reject the recommended XRAs as a result of the CROSA under Article 27(2) of the Contested Decision's ROSC, especially in the ID timeframe, the Board of Appeal notes that the rejection of a single XRA does not require the reiteration of the CROSA but foresees a shorter

coordination process¹¹¹ and that only the rejection of many XRAs will trigger a full reiteration of the CROSA process. In the latter case, a repetition of CROSAs does not seem unreasonably time-consuming, given that Article 3(2) of the Contested Decision's ROSC foresees at least 3 ID CROSAs and that Core TSOs determine the frequency of OS coordination under Article 76(1)(a) SO. Finally, when the CROSA consists of 2 coordination runs (a 1st non-binding run and a 2nd binding run), Article 14(7) of the Contested Decision's ROSC allows Core TSOs to announce that they intend to reject some XRAs after the 1st non-binding run, so that these XRAs are not included in the updated IGM and are not taken into account during the 2nd binding run. This avoids reiterating the full CROSA in case of multiple XRA rejections.

574. In light of the above, under the regional coordination set out by the Contested Decision's ROSC, Core TSOs retain the ultimate responsibility for OS and for managing flows. In so doing, the Contested Decision ensures compliance with Article 78(4) SO: "*When a TSO receives from the relevant regional security coordinator the results of the coordinated regional operational security assessment with a proposal for a remedial action, it shall evaluate the recommended remedial action for the elements involved in that remedial action and located in its control area. In so doing, it shall apply the provisions of Article 20. **The TSO shall decide whether to implement the recommended remedial action.** Where it decides not to implement the recommended remedial action, it shall provide an explanation for this decision to the RSC. Where the TSO decides to implement the recommended remedial action, it shall apply this action for the elements located in its control area provided that it is compatible with real-time conditions.*" (emphasis added). It also ensures compliance with Article 42(2) ER: "*Regional coordination centres shall issue coordinated actions to the transmission system operators in respect of the tasks referred to in points (a) and (b) of Article 37(1). **Transmission system operators shall implement the coordinated actions except where the implementation of the coordinated actions would result in a violation of the operational security limits** defined by each transmission system operator in accordance with the system operation guideline adopted on the basis of Article 18(5) of Regulation (EC) No 714/2009. Where a transmission system operator decides not to implement a coordinated action for the reasons set out in this paragraph, it shall transparently report the detailed reasons to the regional coordination centre and the transmission system operators of the system operation region without undue delay. In such cases, the regional coordination centre shall assess the impact of that decision on the other transmission system operators of the system operation region and may propose a different set of coordinated actions subject to the procedure set out in paragraph 1.*" (emphasis added).

575. The Board of Appeal concludes that the regional coordination methodology of the Contested Decision's ROSC is in accordance with All Core TSOs' SSO responsibilities and duly complies with Articles 35(5)ER and 40(1)(d) and 40(3) Electricity Directive.

576. **It follows that the Fourth Consolidated Plea must be dismissed as unfounded.**

Fifth Consolidated Plea – Disruption of the Central Dispatching Model.

577. Appellant II¹¹² claims that the Contested Decision's ROSC disrupts the use by Core TSOs of the central dispatching model and, consequently, impedes Core TSOs to carry out their responsibilities to dispatch generation and demand response under Article 21(1) ER.

578. Appellant II alleges that the CROSA process is run in a way that is not harmonised with the central dispatching model. Appellant II explains that, in the central dispatching model, the optimisation is realised in a continuous mode, from day D-1 until real time. The integrated scheduling process ("ISP") minimises the costs of covering the demand for energy and operational reserves procurement, based on submitted bids and taking into account network

¹¹¹ Article 27(5) of the Contested Decision's ROSC states: "*In case of rejection of a recommended XRAs, the concerned Core TSOs shall coordinate with Core RSC(s) and other Core TSOs to identify and plan alternative XRAs taking into account cost and efficiency to relieve the operational security violations in a coordinated way in accordance with this methodology and CSAM. In accordance with Article 78(2)(a) of the SO Regulation, the Core RSC(s) may recommend alternative XRAs other than those identified by the concerned Core TSO(s).*"

¹¹² Appeal II, Plea 2, paras 26-33.

and unit technical constraints. The optimisation process run under the central dispatching model takes into account all of TSOs' obligations assigned to them by both European and national law, including ensuring of OS of the national sub-transmission network. Appellant II notes that the optimisation of the central dispatching model covers market-based balancing, CM and reserve procurement on a country-wide basis. Appellant II explains that the CROSA process is much less frequently carried out and foresees minimum-cost elimination of network overloads on monitored elements, which is to be realised by using XRAs provided for this process by all Core TSOs. It only covers out-of-market CM on a region-wide basis.

579. In particular, Appellant II claims (i) that CROSA violates the competence of Core TSOs to use the central dispatching model to manage their power systems by prohibiting Core TSOs from unilaterally amending the schedules or dispatching of generation and demand load facilities if they are affected by a XRA; (ii) that the Contested Decision's ROSC deters the use of the central dispatching model by qualifying all transmission NEs as XNEs and all potential RAs at transmission level as XRAs and does not allow Core TSOs to activate such XRAs and implement them in the updates of their IGMs during the ID process; and (iii) that the rights of dispatchable unit owners are violated as part of their capacity could become unavailable for trading.
580. Appellant II alleges that the Contested Decision infringes (i) Article 4(2)(e) SO because the Contested Decision's ROSC violates the general rule according to which, when applying the SO, Member States, competent authorities and system operators shall respect the responsibility assigned to the relevant TSO in order to ensure system security and (ii) Article 12(1) ER by not allowing TSOs to apply the central dispatching model. Appellant II invokes the proposal for amendment of Article 21 CSAM to reinforce its argument.
581. At the Oral Hearing, Appellant II observed that the CROSA is not sequential to the central dispatching process and that the CROSA does not prevent, but disrupts the central dispatching process.
582. In its Defence¹¹³, ACER responds that (i) TSOs can amend the schedules or dispatching of any generation and demand facilities based on the central dispatching model except the generation and/or demand/load facilities that have been affected by recommended XRAs; (ii) the implementation of XRAs is the result of a CROSA process repeatedly carried out by Core RSCs and Core TSOs; (iii) the proposal for amendment of Article 21 CSAM is under discussion and has not been adopted, (iv) not every change in operating points of generating units or demand response by TSOs resulting from the central dispatching model qualifies as XRA, and (v) in case increasing or decreasing generation/demand of centrally dispatched units would be considered as an XRA, because it is sometimes able to address violations of current limits on XNEs, the generation and load schedules can still be independently defined by the TSO before the first CROSA. ACER therefore responds that the Contested Decision does not unlawfully prevent TSOs to use the central dispatching model and complies with all legal provisions allegedly violated according to Appellant II.
583. Article 12(1) ER states: *"The dispatching of power-generating facilities and demand response shall be non-discriminatory, transparent and, unless otherwise provided under paragraphs 2 to 6, market based."*
584. Article 4(2)(e) ER states: *"When applying this Regulation, Member States, competent authorities and system operators shall: (...) (e) respect the responsibility assigned to the relevant TSO in order to ensure system security, including as required by national legislation."*
585. Article 2(17) and (18) of Regulation (EU) 2017/2195 establishing a guideline on electricity balancing ("**EBGL**") reads as follows:

¹¹³ Defence, paras 254-272.

“(17) ‘self-dispatching model’ means a scheduling and dispatching model where the generation schedules and consumption schedules as well as dispatching of power generating facilities and demand facilities are determined by the scheduling agents of those facilities;

(18) ‘central dispatching model’ means a scheduling and dispatching model where the generation schedules and consumption schedules as well as dispatching of power generating facilities and demand facilities, in reference to dispatchable facilities, are determined by a TSO within the integrated scheduling process.”

586. Article 14 EBGL foresees that TSOs apply a self-dispatching model or a central dispatching model in order to comply with their responsibility for dispatching of generation and demand response. The self-dispatching model is the preferred system but TSOs can still apply the central dispatching model if notified to the regulatory authority.

587. At the Oral Hearing, Appellant II correctly noted that Poland operates under the central dispatching model and that it is a conscious policy choice of Poland allowed by EU regulation.

588. Both the self-dispatching and central dispatching models of the EBGL are market processes that allow TSOs to determine generation and consumption schedules.

589. Per definition, market processes may be limited by CM processes, such as RAs. This applies to both non-XRAs and XRAs resulting from the Contested Decision’s ROSC.

590. The CROSA of the Contested Decision’s ROSC interacts as follows with local (self- or central dispatching):

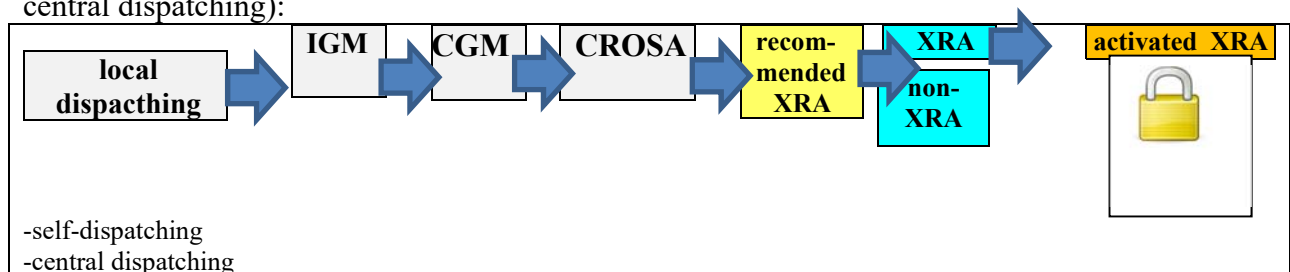

Source: Board of Appeal

-Core TSOs or scheduling agents locally dispatch generation and demand units in order to determine generation and consumption schedules in order to balance the system.

-The available scheduling data following local dispatching need to be included in Core TSOs’ IGMs. TSOs may unilaterally define generation or demand schedules resulting from market activities or central/integrated dispatching processes (e.g. TSOs define the output of a generator based on market processes or central dispatching).

-Core TSOs’ IGMs are consolidated into a CGM.

-The CGM is fed into the CROSA.

-The CROSA is carried out repeatedly by Core RSC(s) in coordination with Core TSOs (see Sub-plea 1.1.3)

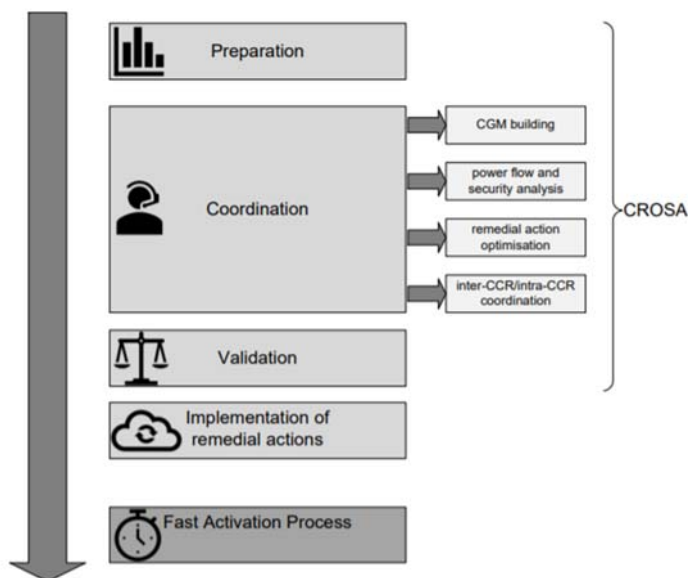

Figure 1: Overview Coordinated Regional Operational Security Assessment (CROSA)

process

Source: ENTSO-E Explanatory Document to the Core CCR ROSC in accordance with Article 76 SO¹¹⁴.

-The output of the CROSA is a recommended XRA.

=> the CROSA can modify the generation or demand schedules resulting from market activities or central/integrated dispatching processes (e.g. it can modify the generator output as part of XRA activation).

-Recommended XRAs are converted into XRAs unless they are rejected by Core TSOs.

-XRA connecting TSOs activate XRAs at the last time compatible with technical, operational and procedural constraints of the resources in accordance with CSAM¹¹⁵ (as generators are usually activated in the last hour before real-time, except for generation units requiring long lead time for activation, it does not affect the ISP).

=> the changed generation or demand schedules during the CROSA process can no longer be unilaterally modified

591. The Contested Decision's ROSC only relates to the CROSA.

592. The Contested Decision's ROSC does not relate to amendments of generation and load schedule before the CROSA, i.e. during local dispatching or in the IGM¹¹⁶ or CGM.

593. Following the CROSA, there is a constraint on amending generation and load schedules: if a XRA is activated on a generation unit (i.e. the request has been sent to the owner/operator of the generation unit), the generation of that unit is locked and cannot be amended in the opposite direction for the remainder of the trading period. Core TSOs need to respect the outcome of the CROSA. If the generation could be unilaterally amended, whether by the

¹¹⁴ Annex 22 to the Defence.

¹¹⁵ There is no inconsistency between the assertion that XRAs are usually activated at the last possible moment and the fact that during the transitional implementation of the Contested Decision's ROSC there will be only a DA CROSA. Core TSOs will always wait for the latest possible moment (also in the transitional implementation period during which there is no ID CROSA) because the recommended XRA can be rejected during the coordination process pursuant to Article 27 of the Contested Decision's ROSC, even during the ID period. In other terms, the recommended XRAs in the DA CROSA will not necessarily be activated in the DA period.

¹¹⁶ Article 70(3)(c) SO states that the IGM should contain the available results from the scheduling tasks. Article 40(3) and (4) SO states that TSOs should share information concerning inter alia generation, consumption and schedules with all other TSOs via inclusion in the IGM to the extent that it is necessary for carrying out the OS analysis.

owner/operator, the scheduling agent or the local TSO, XRA activation would be inefficient. This would jeopardise the CROSA and violate its objectives of OS and CM coordination. The objective of the Contested Decision's ROSC is to ensure that the operation of the network process takes place in an operationally secure manner by coordinating RAs.

594. Even though there is no express provision in the Contested Decision's ROSC in relation to the constraint of consistency of post-CROSA trading with activated XRAs, it is based on the applicable regulatory framework: Articles 21(1)(b) SO and 35(4) CACM prohibit Core TSOs to activate XRAs unilaterally, as this would negatively affect regional coordination. Core TSOs cannot unilaterally deviate from the outcome of the CROSA by adopting other RAs on the same generation or demand units as the activated XRAs, because this would amount to an "*action of cross-border relevance*" which can only be taken in a coordinated way. Market participants and TSOs using a central dispatching scheme are prohibited from amending their market-based generation schedules to the extent that they contradict activated XRAs (e.g. they go in the opposite direction of an activated XRA). If such alterations contradict activated XRAs, EU regulation prohibits them given that the amount to "*actions of cross-border relevance*". That is the reason why TSOs need to include all agreed XRAs determined during the latest CROSA in the ID IGMs according to Articles 13(2) and 32(2) of the Contested Decision's ROSC.
595. Article 13(2) of the Contested Decision's ROSC provides that "*Core RSC(s) shall provide for each intraday CROSAs the list of agreed XRAs from previous CROSAs archived by Core RSC(s) in accordance with Article 30.*"
596. Article 32(2) of the Contested Decision's ROSC provides that "*Each Core TSO shall include all agreed XRAs determined during the latest CROSA in the intraday IGMs as provided in CSAM. Information about all agreed XRAs determined during day-ahead and intraday CROSA shall be archived by Core RSC(s).*"
597. Post-CROSA, trading cannot contradict the activated XRAs. As correctly set out in ACER's Rejoinder, the impact that the Contested Decision's ROSC has on national management processes is limited to what is required by the SO and the CACM, namely to abstain from unilateral activation of XRAs and to coordinate all XRAs which have an impact on the OS of XNEs. To this extent, no national management process, whether based on the self-dispatching or central dispatching model, is allowed to negatively affect the OS on a XNE affected by a XRA. Any trading restrictions going beyond this prohibition to avoid contradictions with previous CROSAs are governed by national laws of Core Member States,
598. As set out by ACER at the Oral Hearing, the Contested Decision's ROSC is developed under the assumption that the results of the local dispatching models are included in the IGMs (which serve as an input to CROSA) and that, if certain congestions are expected to remain following the outcome of local dispatching models, the CROSA will be the last coordinated cm process able to resolve those congestions, the optimised XRAs resulting from the CROSA could entail a correction of the outcome of the local dispatching processes. At the Oral Hearing, ACER set out that the Contested Decision's ROSC has exactly been set up to solve final CM and OS issues: if a unit is affected by such XRA resulting from the CROSA, the TSO responsible of Articles 21(1)(b) SO and 35(4) CACM.
599. The Board of Appeal notes that Appellant II recognised at the Oral Hearing that Article 21(1)(b) SO and Article 35(4) CACM require TSOs to abstain from unilateral action of cross-border relevance.
600. It follows that Appellant II's allegation that the Contested Decision's ROSC impairs the central dispatching process instead of supporting it, as set out at the Oral Hearing, is erroneous.

601. The CROSA does not differentiate between the self-dispatching process and the central dispatching process, contrary to the allegations of Appellant II expressed at the Oral Hearing. Indeed, CROSA does not differentiate between different local dispatching models.
602. Appellant II illustrates its claim with the following example in its Reply: *“It could thus happen that, for example, a generating unit with a capacity of 1000 MW, scheduled to generate 600 MW in a given hour, would be asked to increase its output by 100 MW due to XRA activation. The XRA corrected set point of this unit would be thus 700 MW. Consequently, following the interpretation of the Agency, this generation unit will not be allowed to alter its set point any longer, with the effect that its remaining capacity of 200 MW would be considered as inaccessible for the TSOs outside of CROSA as well as unavailable for trading in wholesale market, even if a further increase of its generation could improve the power system operational conditions in the region”*¹¹⁷.
603. Although the generator will have to abide by national rules and the decision of the national TSO in this respect (as correctly pointed out by ACER in its Rejoinder¹¹⁸), the statement of Appellant II is correct in that post-CROSA, the XRA corrected set point of this unit is 700 MW, which cannot be altered any longer. As set out above, post-CROSA trading cannot contradict the activated XRAs.
604. Given that the key question is that post-CROSA trading does not contradict the activated XRAs, Appellant II’s concerns on the inconsistency between the timing of the CROSA - only a limited number of times per day, namely 1 DA CROSA and 3 ID CROSAs - and the timing of the ISP – continuously run throughout the day, about 50 times per day, with a time resolution of 15 minutes (which will be reduced to 5 minutes in 2023) – is immaterial.
605. In view of the sequential performance of the local dispatching and the CROSA (as set out graphically above), Appellant II’s claim that potential overlaps could disrupt the ISP of the dispatching model is also immaterial. In accordance with the sequential performance, the CROSA will always correct the outcome of local dispatching, in line with its objective. If central dispatching creates congestions on XNECs, the CROSA needs to correct the outcome of central dispatching in order to relieve these congestions. There will never be a contradiction between the central dispatching process and the outcome of the CROSA.
606. The CROSA does not prevent the central dispatching process but, being the last step in the process, can entail changes to the outcome of the central dispatching process. However, as set out above, such changes are in line with the applicable regulatory framework. The CROSA of the ROSC has been designed to be interoperable with local dispatching processes, regardless of whether they are self-dispatching or central dispatching processes.
607. Furthermore, the Board of Appeal notes that the new concerns expressed by Appellant II in its Reply (availability of XRAs under national RD regime, responsibility of TSOs beyond dedicated units contracted as CM reserves, availability of units online, system balancing support, deletion of conditionally shared and non-shared RAs) were not expressed in its initial Appeal. The Board of Appeal finds that the new concerns are either unsubstantiated in Appellant II’s appeal or, by their nature, a matter of national regulation.
608. Finally, the Board of Appeal notes, in relation to Appellant II’s referral to a proposal for amendment of Article 21 CSAM¹¹⁹, that it is still pending discussion and has not yet been adopted and that this draft CSAM amendment is, therefore, unable to challenge the validity of the Contested Decision in the light of the existing applicable regulatory framework.
609. In light of the above, the Board of Appeal finds, first, that it lies in the nature of RAs, both national and regional, to constrain market behaviour in order to allow congestions to be relieved. Second, regional coordination does not eliminate TSOs’ responsibilities related to

¹¹⁷ Reply, para 22.

¹¹⁸ Rejoinder, para 25.

¹¹⁹ Annex 6 to Appeal II.

the electricity trading processes but requires consistency with the CROSA. Allowing inconsistent market behaviour post-CROSA would undermine the rationale of regional coordination all in all. Third, the constraints deriving from the CROSA neither encroach upon the market-based dispatching as foreseen by Article 12(1) ER nor infringe All Core TSOs' SSO responsibilities as per Article 4(2)(e) ER.

610. It follows that the Fifth Consolidated Plea must be dismissed as unfounded.

Sixth Consolidated Plea – Misalignment between locally and regionally optimal RAs to solve congestions.

611. Appellant II¹²⁰ claims that there is a misalignment between the locally optimal and regionally optimal usage of RAs, especially when multiple, simultaneous and interdependent congestions in different parts of a region are being relieved.

612. Appellant II provides an appendix with an example to illustrate this misalignment. Appellant II claims that the misalignment is especially visible with respect to PSTs.

613. Appellant II alleges that, given that regional optimisation of RAs can lead to lower overall CM costs, it must be accompanied by an appropriate regional cost sharing mechanism, i.e. such that allows fair distribution of gains coming from regional optimisation, which is not the case of the RDCTCS. It adds that regional optimisation in its current version leads to a paradoxical situation in which TSOs providing effective RAs for a region may end up bearing more costs, which provides wrong incentives for investment in system development and is not sustainable.

614. Appellant II claims that the Contested Decision infringes Articles 1(c) and 19 ER, 4(1)(f) SO and 1(2) ACER Regulation.

615. In its Defence¹²¹, ACER responds that (i) cost minimisation is not the only objective of the RAO of the CROSA, which is why priority rules were included, (ii) Article 76(1)(b)(v) SO stipulates that the requirements for cost sharing of RAs complement the RDCTCS where necessary and (iii) the RDCTCS does not allocate costs to NEs that are initially not congested. ACER also responds that the Contested Decision does not infringe Articles 1(c) ER, 4(1)(f) SO and 1(2) ACER Regulation.

616. Article 1(c) ER states that the ER aims to “*set fair rules for cross-border exchanges in electricity, thus enhancing competition within the internal market for electricity, taking into account the particular characteristics of national and regional markets, including the establishment of a compensation mechanism for cross-border flows of electricity, the setting of harmonised principles on cross-border transmission charges and the allocation of available capacities of interconnections between national transmission systems;*”

617. Article 4(1)(f) SO states that the SO aims at “*(f) promoting the coordination of system operation and operational planning*”.

618. Article 1(2) ACER Regulation states that “*the purpose of ACER shall be to assist the regulatory authorities referred to in Article 57 of Directive (EU) 2019/944 and Article 39 of Directive 2009/73/EC in exercising, at Union level, the regulatory tasks performed in the Member States and, where necessary, to coordinate their action and to mediate and settle disagreements between them in accordance with Article 6(10) of this Regulation. ACER shall also contribute to the establishment of high-quality common regulatory and supervisory practices, thus contributing to the consistent, efficient and effective application of Union law in order to achieve the Union's climate and energy goals*”

619. Article 19 ER reads as follows:

“1. Congestion-management procedures associated with a pre-specified timeframe may generate revenue only in the event of congestion which arises for that timeframe, except in the case of new interconnectors which benefit from an exemption under Article 63 of this Regulation, Article 17 of Regulation (EC) No 714/2009 or Article 7 of Regulation (EC) No 1228/2003. The procedure for the distribution of those revenues shall be subject

¹²⁰ Appeal II, Plea 3, paras 34-37.

¹²¹ Defence, paras 273-284.

to review by the regulatory authorities and shall neither distort the allocation process in favour of any party requesting capacity or energy nor provide a disincentive to reduce congestion.

2. The following objectives shall have priority with the respect to the allocation of any revenues resulting from the allocation of cross-zonal capacity:

(a) guaranteeing the actual availability of the allocated capacity including firmness compensation; or

(b) maintaining or increasing cross-zonal capacities through optimisation of the usage of existing interconnectors by means of coordinated remedial actions, where applicable, or covering costs resulting from network investments that are relevant to reduce interconnector congestion.

3. Where the priority objectives set out in paragraph 2 have been adequately fulfilled, the revenues may be used as income to be taken into account by the regulatory authorities when approving the methodology for calculating network tariffs or fixing network tariffs, or both. The residual revenues shall be placed on a separate internal account line until such a time as it can be spent for the purposes set out in paragraph 2.

4. The use of revenues in accordance with point (a) or (b) of paragraph 2 shall be subject to a methodology proposed by the transmission system operators after consulting regulatory authorities and relevant stakeholders and after approval by ACER. The transmission system operators shall submit the proposed methodology to ACER by 5 July 2020 and ACER shall decide on the proposed methodology within six months of receiving it.

ACER may request transmission system operators to amend or update the methodology referred to in the first subparagraph. ACER shall decide on the amended or updated methodology not later than six months after its submission. The methodology shall set out at least the conditions under which the revenues can be used for the purposes referred to in paragraph 2, the conditions under which those revenues may be placed on a separate internal account line for future use for those purposes, and for how long those revenues may be placed on such an account line.

5. Transmission system operators shall clearly establish, in advance, how any congestion income will be used, and shall report to the regulatory authorities on the actual use of that income. By 1 March each year, the regulatory authorities shall inform ACER and shall publish a report setting out:

(a) the amount of revenue collected for the 12-month period ending on 31 December of the previous year;

(b) how that revenue was used pursuant to paragraph 2, including the specific projects the income has been used for, and the amount placed on a separate account line;

(c) the amount that was used when calculating network tariffs; and

(d) verification that the amount referred to in point (c) complies with this Regulation and the methodology developed pursuant to paragraphs 3 and 4.

Where some of the congestion revenues are used when calculating network tariffs, the report shall set out how the transmission system operators fulfilled the priority objectives set out in paragraph 2 where applicable.”

6.1 Misalignment between locally and regional optimal RAs to solve congestions.

620. Regarding the alleged misalignment between locally optimal RAs and regionally optimal RAs to solve congestions, Appellant II clarifies in its Reply that a TSO could be able to find locally a set of RAs that is more efficient to tackle congestions **in its own grid** than the set of RAs at regional level. Appellant II adds that it “does not dispute that a regionally optimal solution can indeed be the most effective and economically efficient from a **regional point of view only**” but “there could be a more effective and economically efficient **local** solution from an individual TSO’s point of view”.

621. First, the Board of Appeal observes that the use of local RAs or regionally coordinated XRAs depends on the XRA-test of Article 9(1) of the Contested Decision’s ROSC, as set out in the Fourth Consolidated Plea above.

622. Second, the statements of Appellant II’s Appeal and Reply, transpiring from its emphasis on its “own grid”, are contrary to the quintessence of regional OS coordination. Appellant II’s claim to opt-out from regional coordination when this favours local interests contradicts the rationale of regional coordination all in all. Such opt-out in order to unilaterally serve local interests on a singular grid would hinder regional coordination of OS on Core CCR’s network and would create room for free-riding initiatives, which would undermine regional coordination and jeopardise regional security. It would also violate Articles 21(1)(b) SO and 35(4) CACM. If the locally optimal solution were always identical to the regionally coordinated solution, there would be no need for regional coordination.

623. Regional coordination would be undermined if Appellant II or any other Core TSO could prioritise local interests “*when multiple, simultaneous and interdependent congestions in different parts of a region are being relieved*”, as claimed by Appellant II in its Appeal. Coordinating the relief of multiple, simultaneous and interdependent congestions in different parts of the Core region is performed by regional coordination. The cost-efficiency of regional coordination needs to be evaluated at regional level and not at BZ level. As set out by ACER at the Oral Hearing, it cannot be excluded that the share of a specific BZ in the costs of the coordinated solution is higher than if the TSO had only performed a local assessment and, similarly, that the share in the costs of the coordinated solution could also be lower for a given TSO. However, by definition, the overall costs of the coordinated solution should be lower than the costs of all local solutions together. Regional coordination does not infringe the applicable regulatory framework but is required by the applicable regulatory framework. If Appellant II were to allege that regional coordination is inefficient, this could be tabled in amendment to the Contested Decision’s ROSC in accordance with the SO.
624. At ROSC level, the Contested Decision contains sufficient checks and balances to enable regional security coordination in accordance with the applicable regulatory framework whilst striking a balance with local interests and responsibilities and provides necessary monitoring, review and amendment clauses to rectify misalignments. At RDCTCS level, ACER Decision 30/2020 contains a fair, non-discriminatory cost sharing solution that provides correct incentives and economic signals and ensures the long-term development and operation of the grid and electricity market at EU level, with necessary monitoring, review and amendment clauses to rectify misalignments.
625. Third, if a RA falls within said scope, the Contested Decision’s ROSC aims at identifying the most effective and economically efficient RAs in case of OS violations, in accordance with Article 76(1)(b)(iii) SO. Article 24 of the Contested Decision’s ROSC, entitled “*Economic efficiency and effectiveness*”, accordingly foresees that the RAO of the CROSA determines the optimal set of XRAs and their volumes in accordance with 3 objectives that are stacked along the following priorities: (a) *aim to relieve operational security violations in accordance with Article 22 and 23; (b) aim to minimise total sum of costs and revenues of XRAs; and (c) aim to minimise the amount and volume of XRAs.*”
626. Appellant II provides the following numerical evidence as an Appendix to the Appeal:

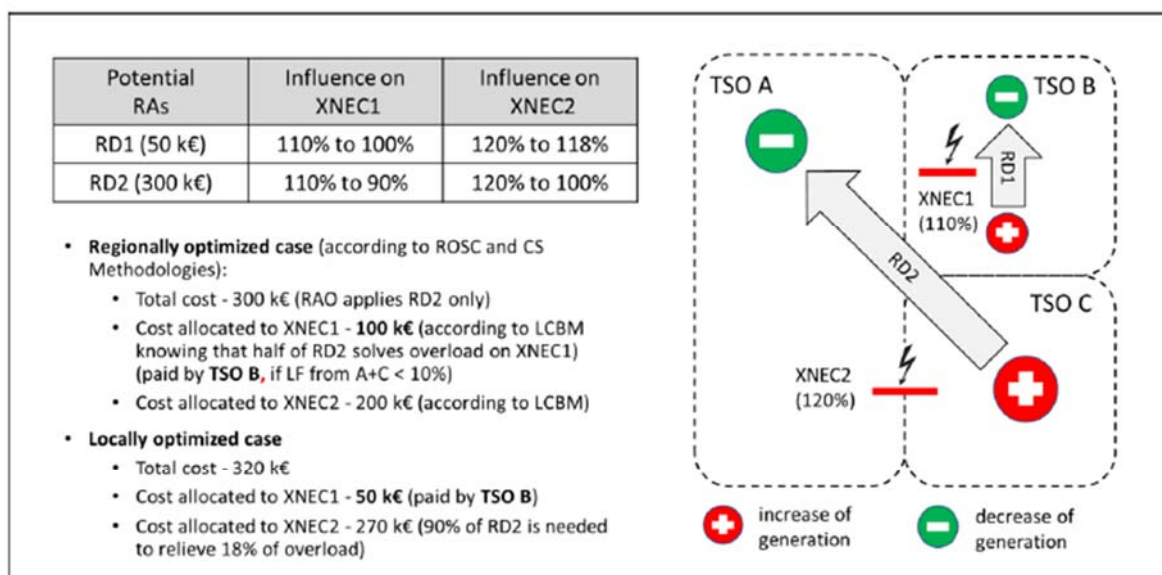

Figure 1. Illustrative numerical example presenting that payment of TSO B in regionally optimised case according to ROSC Methodology is higher than in locally optimised case. Abbreviations: RAO – remedial action optimiser, LCBM – mapping method used in CS Methodology.

Source: Appendix to Appeal of Appellant II.

627. The Board of Appeal notes, with respect to this numerical evidence, that the possibility that an occasional more costly situation for one regional stakeholder can occur in the short term is inherent to regional coordination. If this situation were to be regular and systematic or affect all regional stakeholders, an amendment of the regional coordination instruments would be justified. To this end, Article 35 of the Contested Decision’s ROSC provides for a robust reporting and monitoring process, including (i) the submission of a biannual report by Core TSOs and RSCs to Core NRAs on the efficiency and effectiveness of the ROSC process, (ii) a possibility for Core NRAs (which are to be consulted regarding the detailed specification of the reporting and data delivery requirements) to request additional reporting and data delivery in coordination with Core TSOs and RSCs and (iii) an obligation on Core TSOs to develop a description of national rules and procedures for activation of RAs, focusing on RD actions, within 6 months of the adoption of the Contested Decision’s ROSC.

628. Article 35 of the Contested Decision’s ROSC reads as follows:

“1. Core RSC(s) shall record and share all necessary data to enable Core TSOs and RSC(s) to fulfil the obligations regarding this methodology, the cost sharing methodology and Articles 14 and 17 of the SO Regulation. This data shall be stored for at least 3 years and shall be made available to Core regulatory authorities at request.

2. Core TSOs and RSC(s) shall perform regular monitoring of the efficiency, effectiveness and robustness of ROSC process after its implementation. This shall in particular include the following:

(a) Monitoring of the input data and inclusion of agreed XRAs in IGMs in accordance with Articles 17 and 33; (b) Monitoring of deviations between indicative and realised prices and/or costs of XRAs and their impact on efficiency and effectiveness of RAO pursuant to Article 34;

(c) Monitoring the need, the effectiveness and the impact of the reduction of current limits due to variations of forecasts in consumption, RES production, and market activities in accordance with Article 26;

(d) Monitoring the occurrence and the reasons for the use of the fast activation process pursuant to Article 33; and

(e) Monitoring the need, the effectiveness and the impact of the operational security violations on scanned elements in accordance with Article 23.

3. Core TSOs and RSC(s) shall prepare and submit to Core regulatory authorities on biannual basis a report on efficiency and effectiveness of ROSC process. This shall in particular include:

- (a) Reporting on the occurrence and impact of rejected XRAs in accordance with Article 27;
- (b) Reporting on the deviations between indicative and realised prices and/or costs of XRAs, their impact on efficiency and effectiveness of RAO as well as possible abuses and rejections to include those deviations in cost sharing in accordance with Article 34 and Article 35(2)(b);
- (c) Reporting on input data and inclusion of agreed XRAs in IGMs in accordance with Article 35(2)(a);
- (d) Reporting on the robustness of XRAs in accordance with Article 35(2)(c).
- (e) Reporting on the occurrence and the reasons to use the fast activation process in accordance with Article 35(2)(e).

4. Core TSOs and RSC(s) shall make available to Core regulatory authorities at their request the following data regarding the ROSC process:

- (a) For each timestamp, each CROSA and each XNEC relieved by RAO: The list of XNECs relieved by RAO, their loading before and after RAO, applicable current and flow limits;
- (b) For each timestamp, each CROSA and each XRA recommended by RAO and ordered XRA: The prices and/or costs used in RAO, the volumes determined by RAO, the type of XRAs, the ordered volume of XRAs, the final settled cost of XRAs;
- (c) The loading of XNEC defined in point (a) in real-time (based on e.g. real time snapshots).

5. Core TSOs and RSC(s) shall consult and coordinate with Core regulatory authorities regarding detailed specification of the above reporting and data delivery requirements. Core regulatory authorities shall have the right to request additional reporting and data delivery in coordination with Core TSOs and RSC(s), or to withdraw the requirement for specific reporting or data delivery, if they consider it no longer valid. Core TSOs, RSC(s) and regulatory authorities shall cooperate to avoid duplication of reporting and data delivery requirements.

6. By no later than 6 months after adoption of this ROSC Methodology, each Core TSO shall develop a description of national rules and procedures for activation of remedial actions, with specific focus on redispatching actions. This description shall entail all relevant information that is required for understanding of these rules and procedures. For cost-based compensation of redispatching actions, the description shall clearly list the different cost categories, and identifies which cost categories are to be considered as incurred costs in the cost sharing methodology. It shall also include the planning on future evolution of these rules and assessment of potential incompatibilities with this ROSC Methodology. This assessment shall be updated on an annual basis and provided to Core RSC(s), Core TSOs and Core regulatory authorities.”

629. Article 7 SO also provides for the possibility of Core NRAs and Core TSOs to request amendments to the Contested Decision’s ROSC. Article 7(4) SO provides that “TSOs responsible for developing a proposal for terms and conditions or methodologies or regulatory authorities or designated entities responsible for their adoption in accordance with paragraphs 2, 3 and 4 of Article 6 may request amendments of those terms and conditions or methodologies. Proposals for amendment to the terms and conditions or methodologies shall be submitted to consultation if applicable in accordance with the procedure set out in Article 11 and approved in accordance with the procedure set out in Articles 5 and 6.”

630. Similarly, the RDCTCS (ACER Decision 30/2020) contains monitoring obligations (Article 10 RDCTCS) and reporting obligations (Article 11 RDCTCS), as well as a mandatory annual review obligation to identify possible improvements of the cost sharing methodology with respect to meeting its objectives and purposes, effectiveness (reasonable financial planning, providing correct incentives for managing congestions in an efficient way), efficiency (deadlines for data delivery and settlement) and quality of cost estimations (Article 12 RDCTCS). Article 12 of the RDCTCS of ACER Decision 30/2020 also obliges Core TSOs to develop a proposal for amendment within 12 months of the implementation of the RDCTCS in order to improve the cost sharing mechanism.

6.2 Inadequate cost sharing solution in ROSC and RDCTCS.

631. Appellant II also challenges allegedly inadequate cost sharing stemming from the Contested Decision’s ROSC (the initial CGM based on individual IGMs provided by TSOs determines the starting-point of the CROSA) and RDCTCS of ACER Decision 30/2020, which does not provide correct incentives in relation to regional coordination.

632. The Board of Appeal observes that the Contested Decision (ROSC), ACER Decision 30/2020 (RDCTCS) and ACER Decision 35/2020 (RDCT) are 3 intertwined and interdependent

methodologies but that each of them serves a specific purpose. The Contested Decision coordinates OS at regional level, whereas ACER Decision 30/2020 provides a cost sharing solution for regionally coordinated costly XRAs.

633. Given that the Contested Decision's ROSC coordinates OS at regional level, its primary objective is not cost minimisation but OS. Its primary objective is to identify the most effective RAs in case of OS violations, in accordance with Article 76(1)(b)(iii) SO. Article 24 of the Contested Decision's ROSC accordingly foresees that the RAO of the CROSA determines the optimal set of XRAs and their volumes in accordance with 3 objectives that are stacked along the following priorities:
- 1st priority: aim to relieve OS violations in accordance with Article 22 and 23;
 - 2nd priority: aim to minimise total sum of costs and revenues of XRAs;
 - 3rd priority: aim to minimise the amount and volume of XRAs.
634. Appellant II errs when stating that the cost criterion is in reality the dominant one in the Contested Decision's ROSC because OS needs to be respected in any event. The primary objective of the Contested Decision's ROSC is OS. The legal basis of the ROSC is Article 76 SO, which requires regional OS coordination in line with the CSAM, mandates the set-up of the CROSA and the involvement of RSCs. The Board of Appeal refers to the diagram of Sub-plea 1.1.6 of the First Consolidated Plea. Regional cost efficiency is secondary to regional OS.
635. The secondary objective of the Contested Decision's ROSC is regional cost efficiency and not local cost efficiency. Appellant II's claim relates to local cost efficiency. As set out above in Sub-plea 6.1, the regionally most cost-efficient solution is not the sum of all local most cost-efficient solutions but guarantees cost-efficiency at Core level.
636. The RDCTCS of ACER Decision 30/2020 provides a cost sharing solution that complies with Article 74 CACM and the CM principles of the ER. It provides incentives to manage congestion, including RAs and incentives to invest effectively (Article 74(6)(a) CACM), ensures a fair distribution of costs and benefits between Core TSOs (Article 74(6)(c) CACM), complies with the principles of transparency and non-discrimination (Article 74(6)(i) CACM) and facilitates the efficient long-term development and operation of the pan-European interconnected system and the efficient operation of the pan-European electricity market (Article 74(6)(e) CACM).
637. Finally, ACER Decision 30/2020 (RDCTCS) shares cost of regionally coordinated XRAs. XRAs are activated to relieve congestion on congested XNEs. For XRAs to be activated, there needs to be congestion in the first place. ACER Decision 30/2020 does not share costs for actions that are taken on not-congested NEs.
638. In this context Appellant II's additional claim in its Reply that a congestion-free IGM does not always lead to a congestion-free CGM and that a congestion-free CGM is not fully in the hands of individual TSOs confirms the necessity of regional coordination: individual TSOs may try to obtain a congestion-free IGM, based on the data available to them, but if a congestion remains or appears in the CGM, the CROSA will solve these congestions by XRAs.
639. Appellant II underlines in its Appeal that the misalignment between locally optimal and regionally optimal RAs is especially visible with respect to PSTs.
640. In this respect, the Board of Appeal observes that PSTs are duly taken into account in regional coordination. ACER's analysis, set out in the Defence¹²², is correct: *“Thirdly, the RDCTCS Methodology does not allocate costs to network elements which are initially not congested. Therefore, if a TSO expects that a XRA such as a phase-shifting transformer (PST) will be set to a level that will address local*

¹²² Defence, para 281.

congestions (so that these congestions no longer exist), it can define its setting in the IGM in that way. Afterwards regional coordination under the CROSA process (ROSC Methodology) can modify such PST to increase congestion on these network elements and orders to activate redispatching RAs instead. However, the cost of these RAs will not be allocated to the network elements which were not congested initially (i.e. because they were relieved by the PST RA through the initial setting defined by a TSO).³¹⁵ Hence, it is not true that the RDCTCS Methodology discourages investments in PSTs. To the contrary, without these PSTs, the congested network elements could not be relieved with locally defined PSTs and consequently significant costs would be allocated to these network elements because of the XRAs needed to solve their congestion.”

“Footnote 315: These amendments reflect the agreement that TSOs can define the initial setting of PSTs in the IGM based on the forecast on how they will be set in real time. But, they should not optimise them to minimise the costs and shift congestions to other TSOs”

641. The Board of Appeal notes that Article 10(2) of ACER Decision 30/2020 (RDCTCS) avoids excessive initial settings by compelling Core TSOs to monitor the forecasting accuracy in the IGMs, in particular the settings of PST tap positions: “All Core TSOs shall monitor the forecasting accuracy of network topology, generation and load in the individual grid models that are used for cost sharing and in particular the settings of PST tap positions. In case one or more Core TSOs identify or suspect abusive behaviour (such as systematic forecast errors) or other negative impact of such forecasting, all Core TSOs shall further investigate whether the concerned TSO has gained any financial advantage from such behaviour.” The RDCTCS of ACER Decision 30/2020 discourages the use of excessive PST settings.
642. Investments in PSTs are not discouraged by the Contested Decision or by ACER Decision 30/2020 (RDCTCS). The initial PST setting, based on the best-forecast approach, is included in the mapping of the RDCTCS and can, therefore, avoid that the costs of costly RAs are attributed to NEs whose congestion can be resolved by non-costly RAs, such as PSTs.

6.3 Infringement of the ER, SO and ACER Regulation.

643. Appellant II claims that the misalignment between locally optimal and regionally optimal RAs amounts to an inconsistency with infringes the aim to set fair rules for cross-border exchanges in electricity, as per Article 1(c) ER.
644. As set out above in Sub-Plea 6.1, Appellant II’s claim to rectify an alleged misalignment between locally and regionally optimal RAs amounts to requesting an opt-out from regional coordination in order to favour local interests, which would not only be contrary to the quintessence of regional coordination but also infringe the applicable regulatory framework of the ER, SO and CACM, requiring regional coordination. Both the Contested Decision (ROSC) and ACER Decision 30/2020 (RDCTCS) have been taken in line with bottom-up decision-making processes, duly initiated by All Core TSOs.
645. Appellant II claims that Article 4(1)(f) SO is infringed because the Contested Decision (ROSC) and ACER Decision 30/2020 (RDCTCS) provide incorrect incentives to Core TSOs, discouraging them from developing greater RA potential. This is because, in its view, the methodologies take away from Core TSOs’ the possibilities to apply all RAs since all relevant RAs from a TSO perspective are classified as XRAs.
646. As set out above in Sub-Plea 6.1, Appellant II’s claim that regional coordination deprives it from the right to use RAs located in their power system contradicts the essence of regional coordination. Furthermore, the RDCTCS foreseen by ACER Decision 30/2020 has been designed in compliance with Article 74 CACM and the CM principles of the ER, *inter alia*, to provide correct incentives to Core TSOs and ensure that they take the necessary measures to relieve congestion (e.g. duly penalising TSOs causing polluting flows).
647. Appellant II alleges an infringement of Article 1(2) ACER Regulation and Article 19 ER because the Contested Decision does not contribute to consistent, efficient and effective application of EU law by making more difficult or even nullifying the efforts to comply with Article 19 ER with regard to the allocation of congestion revenue to investments aimed at

reducing interconnector congestion. Appellant II claims that this stems from the fact that the Contested Decision's ROSC impairs the ability of a TSO to use PSTs financed by congestion revenue collected by this TSO in order to increase or maintain CZCs of this TSO and reduce CM costs of this TSO.

648. The Board of Appeal refers to Sub-plea 6.2 with respect to Appellant II's concern regarding the use of PSTs. Investments in PSTs are not discouraged by the Contested Decision or by ACER Decision 30/2020 (RDCTCS). These methodologies do not prevent allocating congestion revenue to such investments. Furthermore, Appellant II's claim considers CM in isolation of regional coordination: it emphasises the ability of one Core TSO to apply RAs, financed though congestion revenue collected "*by this TSO*" in order to increase or maintain CZCs "*of this TSO*" and reduce CM costs "*of this TSO*".
649. Finally, the Contested Decision's ROSC and the RDCTCS provided by ACER Decision 30/2020 comply with the applicable regulatory framework: optimal RAs are identified at Core level, beyond local interests, based on the CROSA, and ensuing costs are shared at Core level to ensure that Core TSOs are provided with correct incentives at Core level. In so doing, the Contested Decision's ROSC applies a RAO that prioritises OS at Core level and provides cost-efficient solutions at Core level (Article 24 of the Contested Decision's ROSC).
650. In light of the above, the Board of Appeal finds that the Contested Decision's ROSC does not infringe any of the alleged provisions.
651. **It follows that the Sixth Consolidated Plea must be dismissed as unfounded.**

Seventh Consolidated Plea – Violation of TSOs' OS responsibilities.

652. Appellant II¹²³ claims that the Contested Decision's ROSC does not allow TSOs to monitor and maintain the OS limits of Article 25 SO. In its opinion, it prevents TSOs from applying effective measures to manage voltages, which is a component of their fundamental responsibility.
653. In its opinion, the Contested Decision's ROSC neither provides sufficient measures to manage voltages at regional level nor leaves sufficient measures to manage voltages at the local TSO level. Appellant II alleges that the Contested Decision's ROSC (i) neither allows for the fulfilment of obligations imposed on RSCs in Article 78 SO to monitor and remove violations of OS limits defined in accordance with Article 25 SO during the CROSA, (ii) nor establishes a clear division of responsibility by expressly tasking the TSOs' to manage voltages and to ensure that OS limits relating to voltage are respected, and by defining how actions taken to carry out that task are reconciled with regional optimisation of RAs. Appellant II claims that the Contested Decision's ROSC only deals with OS limits in its Articles 2(3)(c) and 16(1).
654. Appellant II claims that, as a result, the Contested Decision's ROSC infringes Articles 76 and 77 SO in conjunction with Articles 25, 4(1)(d) and (h) and 4(2)(e) SO.
655. In its Defence¹²⁴, ACER responds that the Contested Decision's ROSC fully takes account of the TSOs' responsibility to monitor and maintain OS limits. It refers to Articles 2(3), 13, 16, 22(5) and 23(1) of the Contested Decision's ROSC. On voltage limits, ACER refers to Article 22 of the Contested Decision's ROSC, which determines that all OS limits, except the current limits, need to be managed primarily by individual TSOs in line with Article 34(2) SO. It adds that the Contested Decision's ROSC foresees extra safeguards on voltage limits within the CROSA process. ACER also responds that the approach of the Contested Decision's ROSC on voltage limits complies with the applicable regulatory framework.
656. Article 76 SO states:

¹²³ Appeal II, Plea 4, paras 38-48.

¹²⁴ Defence, paras 285-297.

“1. By 3 months after the approval of the methodology for coordinating operational security analysis in Article 75(1), all TSOs of each capacity calculation region shall jointly develop a proposal for common provisions for regional operational security coordination, to be applied by the regional security coordinators and the TSOs of the capacity calculation region. The proposal shall respect the methodologies for coordinating operational security analysis developed in accordance with Article 75(1) and complement where necessary the methodologies developed in accordance with Articles 35 and 74 of Regulation (EU) 2015/1222. The proposal shall determine:

(a) conditions and frequency of intraday coordination of operational security analysis and updates to the common grid model by the regional security coordinator;

(b) the methodology for the preparation of remedial actions managed in a coordinated way, considering their cross-border relevance as determined in accordance with Article 35 of Regulation (EU) 2015/1222, taking into account the requirements in Articles 20 to 23 and determining at least: (i) the procedure for exchanging the information of the available remedial actions, between relevant TSOs and the regional security coordinator; (ii) the classification of constraints and the remedial actions in accordance with Article 22; (iii) the identification of the most effective and economically efficient remedial actions in case of operational security violations referred to in Article 22; (iv) the preparation and activation of remedial actions in accordance with Article 23(2); and (v) the sharing of the costs of remedial actions referred to in Article 22, complementing where necessary the common methodology developed in accordance with Article 74 of Regulation (EU) 2015/1222. As a general principle, costs of non-cross-border relevant congestions shall be borne by the TSO responsible for the given control area and costs of relieving cross-border-relevant congestions shall be covered by TSOs responsible for the control areas in proportion to the aggravating impact of energy exchange between given control areas on the congested grid element.

2. In determining whether congestion have cross-border relevance, the TSOs shall take into account the congestion that would appear in the absence of energy exchanges between control areas.”

658. Article 77 SO states:

“1. The proposal of all TSOs of a capacity calculation region for common provisions for regional operational security coordination pursuant to Article 76(1) shall also include common provisions concerning the organisation of regional operational security coordination, including at least:

(a) the appointment of the regional security coordinator(s) that will perform the tasks in paragraph 3 for that capacity calculation region;

(b) rules concerning the governance and operation of regional security coordinator(s), ensuring equitable treatment of all member TSOs;

(c) where the TSOs propose to appoint more than one regional security coordinator in accordance with subparagraph (a): (i) a proposal for a coherent allocation of the tasks between the regional security coordinators who will be active in that capacity calculation region. The proposal shall take full account of the need to coordinate the different tasks allocated to the regional security coordinators; (ii) an assessment demonstrating that the proposed setup of regional security coordinators and allocation of tasks is efficient, effective and consistent with the regional coordinated capacity calculation established pursuant to Articles 20 and 21 of Regulation (EU) 2015/1222; (iii) an effective coordination and decision making process to resolve conflicting positions between regional security coordinators within the capacity calculation region.

2. When developing the proposal for common provisions concerning the organisation of regional operational security coordination in paragraph 1, the following requirements shall be met:

(a) each TSO shall be covered by at least one regional security coordinator;

(b) all TSOs shall ensure that the total number of regional security coordinators across the Union is not higher than six.

3. The TSOs of each capacity calculation region shall propose the delegation of the following tasks in accordance with paragraph 1:

(a) regional operational security coordination in accordance with Article 78 in order to support TSOs fulfil their obligations for the year-ahead, day-ahead and intraday time-frames in Article 34(3) and Articles 72 and 74;

(b) building of common grid model in accordance with Article 79;

(c) regional outage coordination in accordance with Article 80, in order to support TSOs fulfil their obligations in Articles 98 and 100;

(d) regional adequacy assessment in accordance with Article 81 in order to support TSOs fulfil their obligations under Article 107.

4. In executing its tasks, a regional security coordinator shall take account of data covering at least all capacity calculation regions for which it has been allocated tasks, including the observability areas of all TSOs in those capacity calculation regions.

5. All regional security coordinators shall coordinate the execution of their tasks in order to facilitate the fulfilment of the objectives of this Regulation. All regional security coordinators shall ensure the harmonization of processes and, where duplication is not justified by reasons of efficiency or by the need to ensure continuity of service, the creation of joint tools to ensure efficient cooperation and coordination between the regional security coordinators.”

660. Article 25 SO states:

“1. Each TSO shall specify the operational security limits for each element of its transmission system, taking into account at least the following physical characteristics:

(a) voltage limits in accordance with Article 27;

(b) short-circuit current limits according to Article 30; and

(c) current limits in terms of thermal rating including the transitory admissible overloads.

2. When defining the operational security limits, each TSO shall take into account the capabilities of SGUs to prevent that voltage ranges and frequency limits in normal and alert states lead to their disconnection.

3. In case of changes of one of its transmission system elements, each TSO shall validate and where necessary update the operational security limits.

4. For each interconnector each TSO shall agree with the neighbouring TSO on common operational security limits in accordance with paragraph.”

661. Article 4(1)(d) and (h) SO states that the SO aims at “(d) ensuring the conditions for maintaining operational security throughout the Union” and “(h) contributing to the efficient operation and development of the electricity transmission system and electricity sector in the Union.”

662. Article 4(2)(e) SO states that “when applying this Regulation, Member States, competent authorities, and system operators shall (e) ensuring the conditions for maintaining a frequency quality level of all synchronous areas throughout the Union;”

7.1 The Contested Decision did not substantially modify All Core TSO’s ROSC Proposal on voltage limits.

663. The Board of Appeal observes that neither Appellant II nor any other stakeholder raised the issue of OS with respect to voltage limits during the public consultation organised by ACER¹²⁵ and the subsequent decision-making process leading-up to the Contested Decision, which started in 2019.

664. The Contested Decision’s ROSC contains various provisions relating to voltage limits. The Contested Decision’s ROSC contains sufficient possibilities for RSCs and TSOs to jointly manage voltage limits.

665. When adopting the Contested Decision, ACER duly reproduced All Core TSOs’ ROSC Proposal¹²⁶.

666. Article 2(3)(a) of the Contested Decision’s ROSC states that “the ROSC Methodology determines the following types of constraints: (a) Operational Security limits: acceptable operating boundaries for secure grid operation. This ROSC Methodology shall cover the following operational security limits: (i) thermal limits of network elements (PATL and TATL); (ii) voltage limits; (iii) stability limits of the transmission system identified in accordance with Article 38(2) and Article 38(6) of the SO Regulation; and (iv) short-circuit current limits of the transmission system (.).” As acknowledged by Appellant II, Article 2(3)(c) of the Contested Decision’s ROSC adds that “Additional optimisation constraints called system constraints are additional optimisation constraints, expressed as current limits on a single or a set of XNEs and scanned elements and necessary to respect operational security limits other than PATL and TATL.”

667. This is in line with Article 2(3)(a) and (c) of All Core TSOs’ ROSC Proposal, which held: “The following types of constraints are considered in this methodology:

¹²⁵ See Annex II to the Contested Decision, containing the results of the public consultation: https://acer.europa.eu/Official_documents/Acts_of_the_Agency/Individual%20decisions%20Annexes/ACER%20Decision%20No%2033-2020_Annexes/ACER%20Decision%2033-2020%20on%20Core%20ROSC%20-%20Annex%20II.pdf

¹²⁶ https://eepublicdownloads.entsoe.eu/clean-documents/nc-tasks/EBGL/SO_GL_A76_CORE_CCR_ROSC%20Methodology.pdf

(a) Operational security constraints: constraints in line with SO Regulation mean a situation in which there is a need to prepare and activate a RA in order to respect operational security limits. The consideration of these constraints within Core ROSC Methodology is further defined in Article 25. The constraints consist of the following: i. Currents and voltages exceeding operational security limits; ii. Violations of stability limits of the transmission system identified in accordance with article 38 (2) and article 38 (6) of SO Regulation; iii. Violations of short-circuit current limits of the transmission system. (..)

(c) Additional optimisation constraints called system constraints are all the optimisation constraints added by Core TSOs, expressed as flow limitation on a single or a set of Secured and Scanned Elements and necessary to respect stability limits or operational security limits other than current limits. These are further detailed in Article 17.”

668. Article 13(1)(f) of the Contested Decision’s ROSC, entitled “*Provision of CROSA inputs*”, provides that “*Each Core TSO shall provide the following input data to Core RSC(s): (..) (f) when relevant, system constraints according to Article 16*”.
669. This is in line with Article 14(1)(c) of All Core TSOs’ ROSC Proposal, entitled “*Provision of the regional operational security inputs*”, which held: “*Each Core TSO shall provide the following input data to Core RSCs: (..) (c) when relevant, system constraints according to Article 17*”.
670. As acknowledged by Appellant II, Article 16(1) of the Contested Decision’s ROSC, entitled “*System constraints*”, provides that “*Core TSOs may apply system constraints in accordance with Article 2 for the purpose of respecting operational security limits other than thermal limits.*”
671. This is in line with Article 17(1) of All Core TSOs’ ROSC Proposal, entitled “*System constraints*”, which held: “*Each Core TSO shall have the right to make available to Core RSCs system constraints in accordance with Article 2 for the purpose of dynamic stability, voltages exceeding operational security limits in the N-situation and after occurrence of a contingency from the Contingency List described in Article 13*”
672. Article 22(4) of the Contested Decision’s ROSC, entitled “*Relieving operational security violations*”, provides that “*For addressing violations of other operational security limits, such as voltage violations, violations of short-circuit current limits or violations of stability limits, each Core TSO should perform local assessment and long-term operational security analysis in accordance with Articles 31, 38 and 73 of the SO Regulation. These violations may be addressed in CROSA during the coordination of XRAs pursuant to Article 27. When addressing these violations by applying additional constraints on XRAs, the concerned Core TSO shall provide to other Core TSOs and Core RSC(s) the reasoning for these constraints in a transparent manner.*” Article 22(5) of the Contested Decision’s ROSC adds that “*Core TSOs may also apply system constraints that reflect other operational security limits referred to in paragraph 4 for the purpose that RAO does not create new or worsen the existing underlying operational security violations. However, RAO shall not resolve these underlying violations as these shall be resolved in accordance with paragraph 4.*”
673. This is in line with Article 25(3) and (4) of All Core TSOs’ ROSC Proposal, entitled “*Relieving operational security violations*”, which held: “*For the detection of other constraints, such as voltage violations, violations of short-circuit current limits or violations of stability limits, each Core TSO should perform local assessment and long-term operational security analysis in accordance with articles 31, 38 and 73 of SO Regulation. When applying such constraints, the concerned Core TSO shall provide to other Core TSOs and Core RSCs the reasoning of these constraints in a transparent manner. 4. Other constraints than current limits may be reflected into system constraints in accordance with Article 17.*”
674. Article 23(1) of the Contested Decision’s ROSC, entitled “*Avoiding additional operational security violations on XNEs and scanned elements*”, states: “*The activation of XRAs determined by the RAO for relieving operational security violations on XNEs: (a) shall not lead to additional operational security violations of operational security limits on XNEs and scanned elements; and (b) shall not worsen eventually existing operational security violations on scanned elements in accordance with Article 6.*”
675. This is in line with Article 26(1) of All Core TSOs’ ROSC Proposal, entitled “*Avoid additional violations of operational security limits on secured and scanned elements*”, which held: “*The activation of RAs identified for relieving operational security limit violations on Secured Elements: (a) Shall not lead to additional violations of operational security limits on Secured and Scanned Elements; (b) Shall not worsen existing operational security limits violations on Scanned Elements in accordance with Article 6.*”

676. With respect to voltage limits, the Explanatory Document to All Core TSOs' ROSC Proposal contained the following explanations: (i) in the general considerations¹²⁷: *“Different kinds of constraints are mentioned in the Core ROSC Methodology: Operational security constraints are most commonly current, short-circuit, voltage or stability constraints. The Core ROSC Methodology shall detect if current limits in N-situation or after occurrence of a contingency are violated. If this is the case, there is a need to prepare and activate a remedial action in order to respect those current limits. For the detection of other constraints, such as voltage violations, violations of short-circuit current limits or violations of stability limits, each Core TSO should perform local assessment and long-term operational security analysis in accordance with articles 31, 38 and 73 of SO Regulation. TSOs will deal with these constraints, thanks to the definition of system constraints or/and local security assessment.”*
- (ii) in relation to the optimisation of RAs¹²⁸: *“An optimization of RAs has to be done in order to identify in a coordinated way the most effective and economically efficient RAs. In order to minimise the complexity for the optimization and considering violations of short-circuit current limits, voltage limits and stability limits are more local issues, the described optimization will aim at solving current operational violations while violations of short-circuit current limits, voltage limits and stability limits shall be tackled by TSOs local security assessment as specified in article 25 (3) of Core ROSC Methodology or by adding further system constraints. The results of the violations of operational security limits resulting from these TSOs local assessments which have impact on the status of available XRAs will be communicated to other Core TSOs and Core RSCs”; and*
- (iii) in relation to the coordination of RAs¹²⁹: *“Core TSOs are allowed to reject RAs proposed by Core RSCs. The following list includes some examples for a required rejection of a RA: • power plants are currently not available; • provided input data is not correct; • a network element trips; • violations of voltage or stability limits identified in local assessments; • violations of operational limits in voltage levels below 220 kV identified in local assessments.”*

7.2 Inadequate rules on voltage limits in the Contested Decision's ROSC.

677. The provisions of the Contested Decision's ROSC, listed in Sub-Plea 7.1, which duly reproduced All Core TSOs' ROSC Proposal, evidence that the CROSA addresses OS limits, including voltage limits, during the coordination of XRAs: voltage limits can be relieved by XRAs resulting from the RAO.
678. Article 22(4) of the Contested Decision's ROSC provides that all OS limits except current limits need to be primarily managed by individual Core TSOs in line with Article 34(2) SO.
679. Article 22(4) of the Contested Decision's ROSC provides that OS violations can also be addressed in the CROSA process after the RAO is finished and during the coordination of XRAs (i.e. the acceptance by TSOs of the recommended XRAs or proposal of alternative XRAs).
680. During the coordination of XRAs, in accordance with Article 22(4) of the Contested Decision's ROSC, Core TSOs can apply additional constraints on XRAs to address voltage violations if necessary (if relieving XRAs do not result from RAO or if such XRAs were rejected), e.g. Core TSOs can propose additional XRAs in case RAO worsened or did not relieve a voltage issue).
681. In accordance with Article 27(5) of the Contested Decision's ROSC, there are extra safeguards allowing Core TSOs to apply system constraints, e.g. Core TSOs can propose alternative XRAs in case RAO worsened or did not relieve a voltage issue.
682. Regarding Appellant II's allegation that the Contested Decision's ROSC should have included minimum power flow constraints, the applicable regulatory framework does not mandate such imposition. When adopting the Contested Decision, ACER consequently did not fail to ensure due regulatory oversight of All Core TSOs' ROSC Proposal (which did not include minimum power flow constraints, as set out above in Sub-Plea 7.1). The Board of Appeal notes that the

¹²⁷ Annex 22 to the Defence, p. 5.

¹²⁸ Annex 22 to the Defence, p. 17.

¹²⁹ Annex 22 to the Defence, p. 21.

issue has never been brought up by Appellant II during the consultations leading-up to the Contested Decision.

683.Regarding Appellant II's allegation that the Contested Decision's ROSC should have included controlled outages of transmission elements, Article 8 of the of the Contested Decision's ROSC provides that RAs classified in accordance with Article 22 SO (except Article 22(1)(d)(h)(i) and (j) SO) can be used for the CROSA process. Consequently, controlled outages of transmission elements can be included in the CROSA process. The Board of Appeal also notes that the issue has never been brought up by Appellant II during the consultations leading-up to the Contested Decision.

7.3 A need for local management of voltage limits.

684.Appellant II claims that voltage limits should be managed locally by Core TSOs instead of regionally.

685.The Board of Appeal refers to Article 22(4) of the Contested Decision's ROSC, which strikes a correct balance between TSOs' responsibilities and the need for regional coordination.

686.Article 22(4) of the Contested Decision's ROSC provides that all OS limits except current limits need to be primarily managed by individual Core TSOs in line with Article 34(2) SO.

687.Article 22(4) of the Contested Decision's ROSC provides that OS violations can also be addressed in the CROSA process after the RAO is finished and during the coordination of XRAs (i.e. the acceptance by TSOs of the recommended XRAs or proposal of alternative XRAs). In this phase, Core TSOs can propose additional RAs protecting the voltage limits.

688.In light of the above, the Board of Appeal concludes that Appellant II did not demonstrate that the Contested Decision's ROSC impedes the maintenance of OS limits, in particular voltage limits. Consequently, the Board of Appeal does not find that the Contested Decision's ROSC infringes Articles 76 and 77 SO, read in conjunction with Articles 25 and 4(1)(d) and (h) and 4(2)(e) SO.

689.If, notwithstanding the safeguards of the Contested Decision's ROSC, unexpected OS limits were to surge during the implementation of the ROSC, All Core TSOs could, having duly taken stock from detailed testing during the implementation, accordingly table an amendment proposal under Article 7(4) SO in order to amend the rules on voltage limits.

690.It follows that the Seventh Consolidated Plea must be dismissed as unfounded.

DECISION

On those grounds,

THE BOARD OF APPEAL

Hereby confirms the Contested Decision and dismisses the Appeals for annulment.

This decision may be challenged pursuant to Article 263 of the Treaty on the Functioning of the European Union and Article 29 of Regulation (EU) 2019/942 within two months of its publication on the Agency website or of its notification to the Appellant as the case may be.

SIGNED

SIGNED



Andris Piebalgs
Chairperson of the Board of Appeal

SIGNED

SIGNED



Ronja Linßen
Acting Registrar of the Board of Appeal

ANNEX – LIST OF ABBREVIATIONS

Acronym	Definition
AC	Alternating Current
ACER	European Union Agency for the Cooperation of Energy Regulators
ACER Regulation	Regulation (EU) 2019/942 of the European Parliament and of the Council of 5 June 2019 establishing a European Union Agency for the Cooperation of Energy Regulators
ACM	Dutch NRA
AEWG	ACER Electricity Working Group
AF	Allocated Flows
AP	Action Plan
APG	Austrian Power Grid
ARERA	Italian NRA
BZ	Bidding Zone
BZB	Bidding Zone Border
CA	Capacity Allocation
CACM	Commission Regulation (EU) 2015/1222 of 24 July 2015 establishing a guideline on capacity allocation and congestion management
CB	Cross Border
CC	Capacity Calculation
CCC	Coordinated Capacity Calculator
CCM	Capacity Calculation Methodology
CCR	Capacity Calculation Region
CEPS	Czech TSO
CGM	Common Grid Model
CGMM	Common Grid Model Methodology
CIDM	Congestion Income Distribution Methodology
CJEU	Court of Justice of the European Union
CM	Congestion Management
CMF	Capacity Management Function
CNE	Critical Network Element
CNEC	Critical Network Element associated with Contingency
CRE	French NRA
CREG	Belgian NRA
CREOS	Luxembourg TSO
CROSA	Coordinated Regional Operational Security Assessment
CSA	Coordinating Operational Security Analysis
CSAM	Coordinating Operational Security Analysis Methodology
CT	Counter-Trading
CWE	Central and Western European region
CZ	Cross Zonal
CZC	Cross Zonal Capacity
D2CF	Two-Days-Ahead Congestion Forecast
DA	Day Ahead
DACF	Day Ahead Congestion Forecast
DSO	Distribution System Operator

EBGL	Electricity Balancing Guidelines
EC	European Commission
ELES	Slovenian TSO
ELIA	Belgian TSO
ENEL	Italian TSO
ENTSO	European Network of Transmission Operators for Electricity
EPO	European Patent Office
ER	Regulation (EU) 2019/943 of the European Parliament and of the Council of 5 June 2019 on the internal market for electricity
Electricity Directive	Directive (EU) 2019/944 of the European Parliament and of the Council of 5 June 2019 on common rules for the internal market for electricity and amending Directive 2012/27/EU
ERO	Energy Regulatory Office
ESMA	European Securities and Markets Authority
EU	European Union
FCA	Forward Capacity Allocation
FLC	Full Load Current
FLD	Full Line Decomposition method
FRM	Flow Reliability Margin
GCEU	General Court of the European Union
GLSK	Generation and Load Shift Key
GSK	Generation Shift Key
HEA	Hungarian NRA
HOPS	Hungarian TSO
HV	High Voltage
HVDC	High Voltage Direct Current
ID	Intra Day
IDCF	Intra Day Capacity Forecast
IF	Internal Flow
IGM	Individual Grid Model
INIF	Imbalance Netting Implementation Framework
INPF	Imbalance Netting Process Function
ISP	Integrated Scheduling Process
IT	Information Technology
ITC	Inter-TSO compensation mechanism
LCBM	Least Cost Based Mapping
LEN	Legal Expert Network
LF	Loop Flow
LSK	Load Shift Key
LTA	Long Term Allocation
MAVIR	Hungarian TSO
MFLD	Multi-stage Full Line Decomposition Method
MRA	Multilateral Remedial Action agreement
MTU	Market Time Unit
NE	Network Element
NEMO	Nominated Electricity Market Operator
NRA	National Regulatory Authority
OLD ER	Regulation (EC) No 714/2009 of the European Parliament and of the Council of 13

July 2009 on conditions for access to the network for cross-border exchanges in electricity and repealing Regulation (EC) No 1228/2003

OPP	Owner Pays Principle
OS	Operational Security
OSA	Operational Security Assessment
PATL	Permanent Admissible Transmission Loading
PCI	Project of Common Interest
PFC	Power Flow Colouring Method
PPP	Polluter Pays Principle
PSDF	Phase Shifter Distribution Factors
PSE	Polish TSO
PSP	Proportional Sharing Principle
PST	Phase Shifting Transformer Flow
PTDF	Power Function Distribution Factor
RA	Remedial Action
RAM	Remaining Available Margin
RAO	Remedial Action Optimisation
RCC	Regional Coordination Centre
RD	Re-Dispatching
RDCT	Re-Dispatching and Counter-Trading Methodology
RDCTCS	Re-Dispatching and Counter Trading Cost Sharing Methodology
RES	Renewable Energy Sources
ROSC	Regional Operational Security Coordination
RSC	Regional Security Coordinator
RTE	French TSO
SEE	South Eastern European region
SEPS	Slovak TSO
SO	Commission Regulation (EU) 2017/1485 of 2 August 2017 establishing a guideline on electricity transmission system operation
SOGCTF	System Operation and Grid Connection Task Force
SOR	System Operation Region
SSO	Secure System Operation
STD	Simple Tie-Line Decomposition
TATL	Temporary Admissible Transmission Loading
TERNA	Italian TSO
TEU	Treaty on the European Union
TFEU	Treaty on the Functioning of the European Union
TSO	Transmission System Operator
TTSF	TSO-TSO Settlement Function
UFE	Union Française d'Électricité
URSO	Slovak NRA
VÜEN	Austrian TSO
XBRNE	Cross-Border Relevant Network Element
XNE	Cross-Border Relevant Network Element
XNEC	Cross-Border Relevant Network Element with Contingency
XRA	Cross-Border Relevant Remedial Action